

RADIO RETAILING

HOME ENTERTAINMENT MERCHANDISING

Year 'Round Profit

Radio

A complete line of Majestic Receivers is always available, changed periodically to meet the public's demands. Behind this line and famous name, Majestic dealers can profitably put every effort with assurance of user satisfaction.

Refrigeration

It's Summer in the Kitchen All Year 'Round, as Majestic Dealers have learned, and sales on Majestic Refrigerators made 1931 a profitable year for thousands. A quality product, priced to present conditions, well-advertised.

Tubes

Majestic Tubes were brought out to insure the perfect performance of Majestic sets, and the high standards to which they were first produced have been rigidly maintained. Made in all popular types, they'll improve the performance of any receiver.

Auto Radio

Motor Majestic has passed the exceedingly difficult tests of leading motor car manufacturers, is not hard to install and finds the lowest sales resistance *in the summer months*. A seven-tube set with low current drain on the battery.

See the Majestic Distributor for your territory.

GRIGSBY-GRUNOW COMPANY, CHICAGO, ILLINOIS
World's Largest Builders of COMPLETE Radio Receivers



Majestic

PRODUCTS

If YOUR Radio Business isn't what it SHOULD BE!



1931 has been Silver-Marshall's best year, because . . .

Silver-Marshall Superheterodynes are sold DIRECT to DEALERS.

The jobbers' profit is used in more profit for the dealers and lower list prices.

Silver-Marshall has a COMPLETE LINE. Full-size superheterodyne consoles to sell from \$49.95 to \$139.50.

In addition to 6, 8, 9, 10 and 12-tube supers, Silver-Marshall dealers have an 11-tube short-and-long wave super.

Silver-Marshall has a unique \$10.00 plan to cover trade-ins, time payments, etc. They do not come out of the dealer's pocket.

A half-million dollars has been spent in the last six months to advertise S-M receivers.

Silver-Marshall dealers have exclusive territory.

Those are SOME of the reasons. We will be glad to tell you the rest of them.



Model C-24. 12 tubes . . . superheterodyne . . . 3-unit construction . . . pentodes in push-pull . . . double tone control . . . built-in tone chamber . . . meter tuning . . . automatic volume control . . . built-in aerial . . . 45-inch door console. A finer receiver is not possible. Complete with Eveready Raytheons . . . \$139.50 list

SILVER-MARSHALL
6421 W. 65th St.
Chicago, Illinois

Please send me all details.

Name

Address

SILVER - MARSHALL

6421 WEST 65th STREET

CHICAGO

ILLINOIS

RADIO RETAILING

HOME ENTERTAINMENT MERCHANDISING

Vol. 15

No. 1

Contents for January, 1932

Copyright, 1932, by McGraw-Hill Publishing Company, Inc.

<i>Visual Entertainment</i>	<i>An Editorial</i>	17
<i>Looking into 1932—A Business Forecast</i>		18
<i>What's Ahead Technically</i>		20
<i>Sales: 53% to People With Old Sets</i> by <i>W. W. MacDonald</i>		22
<i>Broadcasting the Big News Events</i>		24
<i>Outlets for Auto-Radio</i>	by <i>Frank Beaucaire</i>	27
<i>104 Sets in One Day</i>		28
<i>"Arm-Chair" Control</i>		30
<i>Radio's Biggest Co-operative Advertising Splurge</i>		32
<i>How to Refinish Cabinets</i>		34
<i>A De Luxe Store</i>	<i>A Pictorial</i>	36
<i>Lind Proves They're Different</i>		37
<i>15 Minutes per Hour, and other editorials</i>		38
<i>Service Shortcuts</i>		40
<i>News of the Month</i>		42
<i>Two Firms Point the Way</i>		45
<i>New Merchandise</i>		46

O. H. CALDWELL,
Editor

RAY V. SUTLIFFE
Managing Editor

W. W. MACDONALD
Technical Editor

T. H. PURINTON
Assistant Editor

HARRY PHILLIPS
Art Director

P. WOOTON
Washington

M. E. HERRING
Publishing Director

Government Census Confirms Accuracy of Radio Retailing's Statistical Service

LAST month the government completed its national radio census tabulations and announced a total of 12,078,345 radio sets in use as of April 1, 1930.

Beating the government's report by 17 months, *Radio Retailing*, in its March, 1930, issue, page 41, stated that, as of January 1, 1930, there was a total of 11,800,000 sets in use in American homes. Allowing for the three months' difference between the date of the government's compilation and our own, the even more striking agreement of these two sets of figures is at once apparent—proof of the accuracy of the statistical service *Radio Retailing* has been rendering its readers.

Since its inception, seven years ago, *Radio Retailing* everywhere has been recognized as the one authoritative compiler of the sales statistics of the industry it serves. In the light of the above, the basis for this statement is manifest.

1931 Sales Figures Will Appear In Our March Issue

Once again, in our March issue, we will present complete tabulations of the statistical status of the radio industry. Its findings will be fully as accurate and helpful as those of previous releases.

We take this opportunity to thank the many manufacturers who, by their prompt and complete replies to our requests for sales figures, have contributed in no small degree to the accuracy of this statistical service, and to bespeak a similar response to our requests for similar information which are about to be mailed.

McGraw-Hill Publishing Company, Inc.

330 West 42d Street, New York, N. Y.

CABLE ADDRESS:
"MCGRAWHILL"

CHICAGO - - 520 North Michigan Avenue

SAN FRANCISCO - - 883 Mission Street

LONDON, W. C. 2 - Aldwych House, Aldwych

WASHINGTON - - - - National Press Building

PHILADELPHIA - - - - - 1800 Arch Street

CLEVELAND - - - - - 501 Guardian Building

DETROIT - - - - - 2-257 General Motors Building

ST. LOUIS - - - - - 1536 Bell Telephone Building

BOSTON - - - - - 1427 Statler Building

GREENVILLE, S. C. - - - 1301 Woodside Building

LOS ANGELES - - 339 Chamber of Commerce Building

JAMES H. MCGRAW - - - - Chairman of the Board

MALCOLM MUIR - - - - - President

JAMES H. MCGRAW, JR. - - - Vice-Pres. and Treas.

MASON BRITTON - - - - - Vice-President

EDGAR KOBAK - - - - - Vice-President

H. C. PARMBLEE - - - - - Vice-Pres. and Editorial Director

HAROLD W. MCGRAW - - - - Vice-President

C. H. THOMPSON - - - - - Secretary

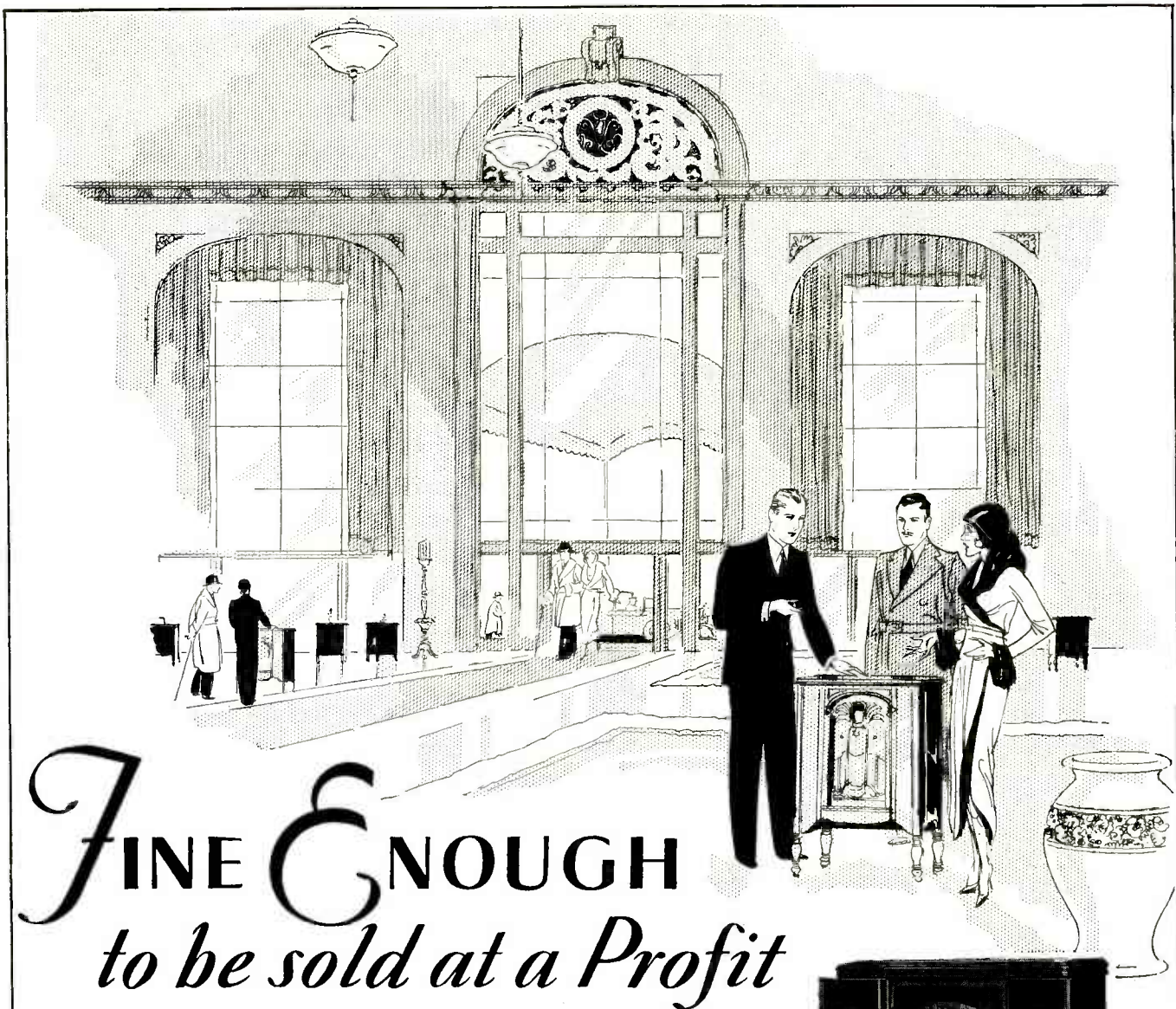

FINE ENOUGH to be sold at a Profit

NEW courage is coming to radio dealers as the slogan "trade-up" spreads. Today, far-seeing merchants everywhere are striving to educate their salesmen to sell higher priced radio units and *thereby show a profit.*

Dealers holding the Stromberg-Carlson Franchise are in a fortunate position. Their salesmen *can* "trade-up". The Stromberg-Carlson unit of sale is high (\$200 average is normal). The Stromberg-Carlson quality justifies the price—and people again are coming to realize that you get what you pay for in radio just as in everything else.

Stromberg-Carlson unsurpassed quality Receivers from \$175 to \$375. The Multi-Record Radio, (automatic radio-phonograph combination, electrical,) \$660. (Time prices, complete with tubes, East of Rockies).

STROMBERG-CARLSON TELEPHONE MFG. CO., ROCHESTER, N. Y.



For Either Long-playing
or Regular Records

No. 26 Superheterodyne with phonograph option. Plays either 33½ R.P.M. (long-playing) or 78 R.P.M. (regular) records. Walnut finish.



1894

Stromberg-Carlson



1932

MAKERS OF VOICE TRANSMISSION AND VOICE RECEPTION APPARATUS FOR MORE THAN THIRTY-FIVE YEARS

Here's Something You Should Know!

Robert Goldschmidt



Any Electrical appliance will perform better if it is
SHAKEPROOF
equipped

WHEN you demonstrate a washing machine—radio, or any other electric appliance, it will pay you to show your prospects why it is certain to give them years of satisfactory service. You can do this quite easily and impressively if the products you handle are Shakeproof equipped.

Shakeproof is vibration's greatest enemy. No nut or screw can possibly loosen when it is turned down tight on this modern lock washer. The patented twisted teeth bite into both the nut and work surface and as vibration increases they bite in deeper.

Give Shakeproof a trial in your service work. See for yourself how it keeps connections tight and assures perfect performance. Free testing samples will be gladly sent on request—mail the coupon today!

U. S. Patents
 1,419,564
 1,504,122
 1,697,954
 1,782,387
 Other patents pending.
 Foreign Patents.



Type 11 External



Type 12 Internal



Type 15 Countersunk



Type 20 Locking Terminals



Shakeproof representatives are located in the following cities:
 New York City; Philadelphia; Boston; Pittsburgh; Schenectady; Cleveland; Detroit; Toledo; Cincinnati; Birmingham, Ala.; Dallas, Texas; Milwaukee; Los Angeles; Seattle; San Francisco; Toronto, Ontario, Canada

SHAKEPROOF

SPECIAL OFFER

Here is a handy kit of Shakeproof Lock Washers and Shakeproof Locking Terminals that is just what you need. It contains an ample supply of many types and sizes, neatly arranged in this special box. It makes a very convenient assortment for the shop and can be easily tucked in the tool bag. Mail the coupon below for free samples and complete information on how you can secure a Shakeproof Service Kit.



COUPON

SHAKEPROOF LOCK WASHER CO.
 (Division of Illinois Tool Works)
 2531 N. Keeler Ave., Chicago, Ill.

Gentlemen: Please send us free samples of Shakeproof Lock Washers and Shakeproof Locking Terminals. Also, tell us more about your special offer on Shakeproof Service Kit.

Firm Name

Address

City State

By Title

WATCH **G-E** *RADIO*
IN **1932**

General Electric Radio goes into 1932 with a full head of steam up and the throttle wide open.

Plans are under way to make this new year the biggest in history for G-E Radio dealers. They're going to have some selling advantages worth getting excited about.

The "Believe Your Own Ears" national advertising campaign is taking hold all over the country. It's building up the knowledge that General Electric—superior in other electrical appliances—is making a superior radio. This outstanding campaign will continue through 1932, month after month, in the largest-circulation magazines in America!

Line up with G-E Radio now. It's a franchise that's going to be more valuable than ever this year. Call your G-E Radio distributor or write to Section R-681, Merchandise Department, General Electric Co., Bridgeport, Conn.

GENERAL ELECTRIC RADIO



STARTING:

AN EVEN GREATER YEAR

FOR *Rollator*

REFRIGERATION DEALERS

Seven years ago the first Norge Electric Refrigerator was built

Back of it was an idea . . . the Rollator! In this mechanism, long the ideal of refrigeration engineers, the rotary compressor, was made practical . . . a simple, powerful, compact unit, almost everlasting.

Even now the first Norge refrigerators are giving consistent day after day performance. And there is every reason to expect them to continue doing so for many more years.

Norge has found no way to improve on the powerful, simple Rollator. But Norge has contributed many new user conveniences and introduced original advancements and exclusive features in refrigeration.

These advantages and the superior Rollator mechanism, last year, brought Norge from a place as one of many refrigerators, to an impressive position with the leaders of the industry.

Twelve months ago we promised Norge Dealers a BIG year. Now we promise an even greater year to Norge Rollator Refrigeration Dealers.

If you would share in a prosperous, profitable year ask about the Norge Dealer Plan, now.

NORGE CORPORATION, 654 E. WOODBRIDGE ST., DETROIT, MICHIGAN

Norge Corporation is a division of Borg-Warner Corporation, one of the world's largest makers of automotive parts, including free wheeling.

NORGE

Rollator refrigeration

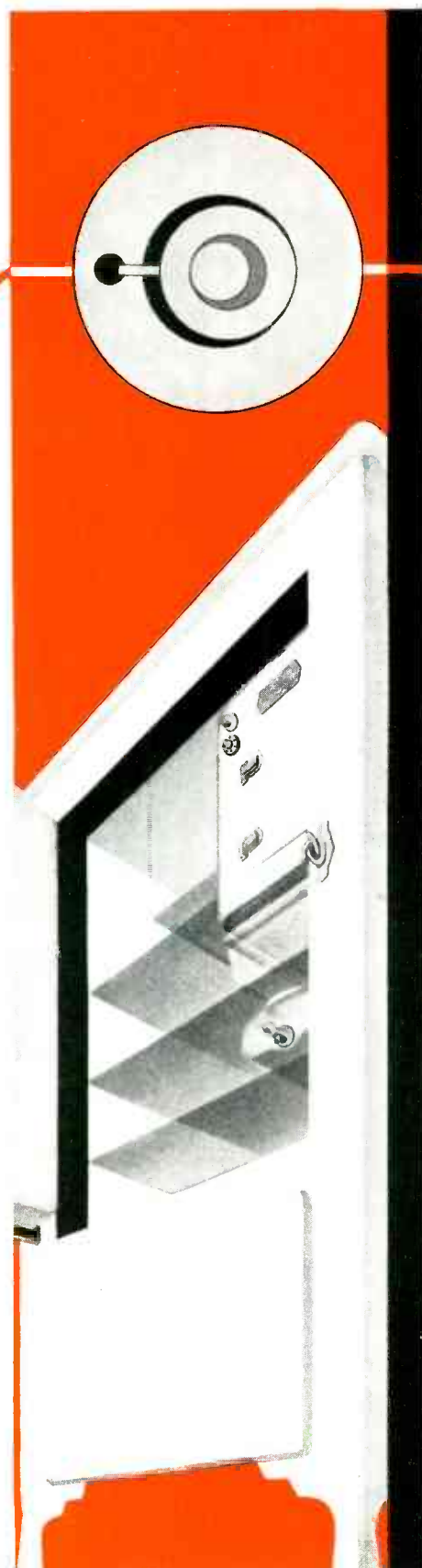

THE ROLLATOR

Simplest electric refrigeration mechanism, the Rollator is powerful, compact, trouble free and almost everlasting.



QUICK FACTS

No kitchen repairs,
intricate adjust-
ments, or replace-
ment of parts . . .
No moving parts
exposed, and
fewer of them . . .
Clean, quiet and
economical . . .
Compact cabinets
with even more
shelf space . . . No
installation prob-
lem in any building

Simplified Selling

with the

SERVEL HERMETIC

HERE'S the refrigerator that fits quickly and smoothly into your business. You can add this new source of profits without upsetting the methods of your organization.

The Servel Hermetic frees you from an expensive and highly trained installation and service organization.

The highly simplified working unit is her-

metically sealed in a bath of oil—permanently protected from dust, rust and moisture. It needs no attention—not even oiling.

Women are eager for the “carefree” refrigeration of the Servel Hermetic. They promptly appreciate its extreme operating economy, its quietness, its roominess.

You'll have a product incorporating selling points unmatched by any other. And you know that electric refrigerators have been selling fast and steadily even when general conditions were worst.

Write now for full details of our attractive Dealer Plan—for prices and discounts—for an outline of our Sales Plan for 1932.

SERVEL SALES, INC., Evansville, Indiana
Manufacturers of a complete line of household and commercial refrigeration

... and now the new.

ALL-ELECTRIC Motorola

the supreme achievement in

Auto Radio

Eliminates "B" Battery and "B" Battery Troubles. Increases Sales and Customer-Satisfaction . . .

**Two New
1932
MODELS**

Motorola Deluxe—7-tube T. R. F.

Motorola Super-Deluxe 8-tube Superheterodyne

All Electric. Very newest tube setup. Newest application of push-push output method and of variable mu tubes to automobile design.

Truly, an *electrifying* announcement;— As pioneers in Auto-Radio we are proud to present its newest and greatest engineering triumph—the *All-Electric Motorola*. It eliminates the "B" Battery and "B" Battery troubles—a tremendous *Sales and Performance* advantage. Further: it offers two new 1932 Models, a 7-tube T. R. F., and an 8-tube Superheterodyne, thoroughly engineered for Finer Tone Quality, Automatic Volume-Control, Elimination of Motor-Noise, and Easier Installation than possible with any previous models. This is *Your* big merchandising *Opportunity* of 1932. Send for the *Profitable* facts *Now*.

Look for the All-Electric Motorola on display and in performance at the Automobile Shows throughout the country

GALVIN MFG. CORPORATION
847-851 West Harrison Street, Chicago, Illinois

Mail this
Coupon for
full details
TODAY

GALVIN MFG. CORPORATION, 847-851 W. Harrison St., Chicago, Ill.
Please send full information regarding the new All-Electric Motorola, including two 1932 Models. Also advise name and address of your nearest distributor. R

Name.....
Address.....
City and State.....

ATWATER KENT RADIO

Playing Ball *with the* Dealer!

EVEN in the difficult years of 1930 and 1931, Atwater Kent didn't try to stock you beyond your requirements.

You were not "crowded" or "loaded." You bought according to your needs, with no high-pressure attempt to break down your judgment.

That is the safe way, the sane way, the fair way.

Atwater Kent is able to follow that way because Atwater Kent production is accurately adjusted to the known possibilities of the market.

You have no Atwater Kent overstock because *we* have none.

Safety! Security! Stability! Peace of mind! Assurance of reasonable profit—without fear of "dumping" and price convulsions.

That's what the name Atwater Kent means on your merchandise. Last year—this year—**EVERY** year!

ATWATER KENT MANUFACTURING COMPANY

A. Atwater Kent, *President* · 4700 Wissahickon Avenue, Philadelphia, Pa.

Summon Your Business for trial in 1932

IT is up to you, Mr. Radio Dealer, to chart your course for 1932. Economists indicate that business revival is already under way, but that the rebuilding of business must be on different and sounder principles. Today you must summon your own business for trial. You must weigh carefully your possibilities and decide now whether you will build with the times or stagnate. Radio tubes are being sold and will continue to be sold as long as radio tubes require replacement. The radio tube replacement market has reached tremendous volumes and this market can constitute an important and profitable part of your business. The sale of radio tubes, however, must be undertaken with the idea of making it both beneficial and profitable.

What tube is it wise to select?

You want quality. The quality of a tube can best be gauged by its approval and use by the most reputable set manufacturers.

You want acceptance. Select that tube that has grown in public sales without being slaughtered in price to produce sales results.

You want a tube that is not imitative, but that has led in the development of the art. Study the major advances since the introduction of a.c. tubes and select the progressive manufacturer.

You want a tube that is individual and has characteristics that distinguish it from all other tubes.

You want a tube that is profitable to handle. Your profit can only be safeguarded if the price of a tube is not slaughtered on the market, because price maintenance means insurance of profits that rightfully belong to you.

If you select these vital factors you can build soundly for the future. You will not find your shelves stocked with obsolete merchandise. You will not find that you have to sacrifice profit to get a turnover. You will then be in tune with the new business revival.

By your decision now, you chart your own course for 1932

Arcturus Radio Tube Company, Newark, N. J.

WANTED

for New Long Playing 33 $\frac{1}{3}$ and present 78 r.p.m. Records

Model D Specifications

Pushing a handy lever shifts the speed. Governor control permits 10% range of speed adjustment. All gears laminated Bakelite, spiral-cut, and completely enclosed, running in oil. Long over-size self-lubricating bearings. Self-starting induction type, with ample power for all records. For all voltages and frequencies; also supplied for direct current, either 110 or 220 volts. Furnished complete with turntable, speed regulator dial and speed change escutcheon. Automatic stop is optional. Complete with 10 inch turntable, retail list price, \$15.00.



Order NOW, from any reliable Jobber, or direct from us.

In ordering, please specify voltage and frequency needed, and whether 10" or 12" turntable.

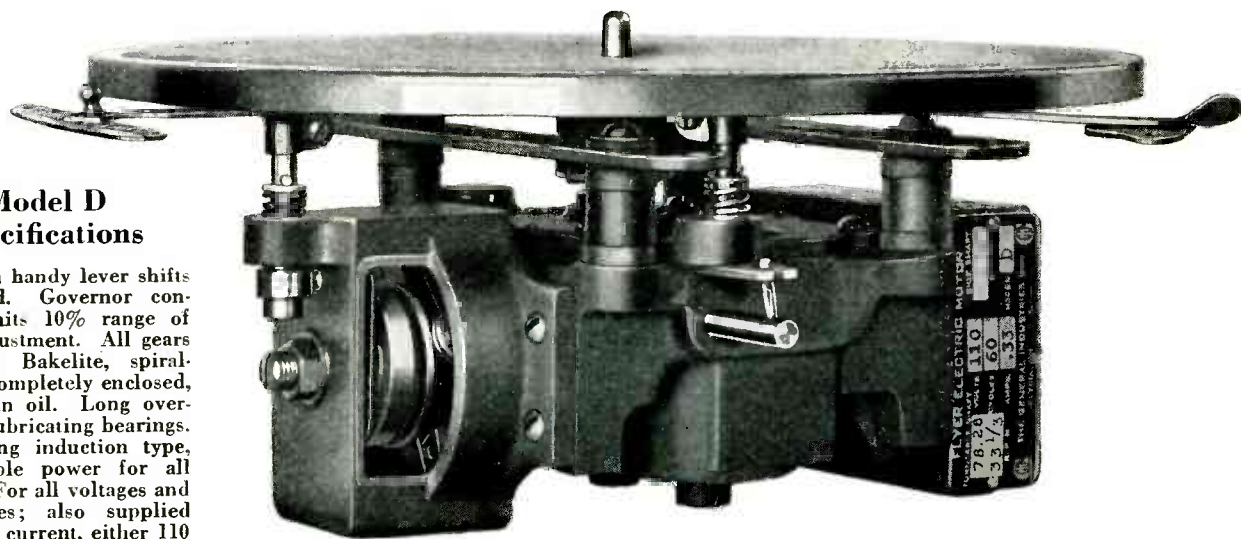

Two-Speed Green Flyer

MR. DEALER, your customers want *this* new two-speed governor-controlled electric Radio-Phonograph Motor—plenty of them. For four good reasons that mean something to them and to you, as follows:

It plays *both* the new 33 1/3 r.p.m. long-playing records, that everybody wants, and the present 78 r.p.m. records. That's two reasons. It has 17 years of phonograph-motor manufacturing success and a quarter century of electrical manufacturing success back of it. That's the other two reasons. To you four plain, matter-of-fact, sensible reasons for ordering a sample *at once!*

The GENERAL INDUSTRIES CO.

3214 Taylor Street, Elyria, Ohio

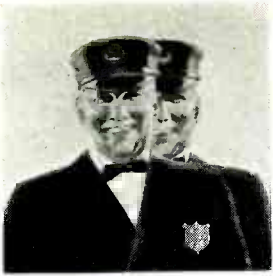

THE Westinghouse

Dual-automatic Refrigerator

IS HERE TO STAY!

Go back five years in your trade magazines and look at refrigerator advertising. How many of these companies are in business today?

Then compare *Westinghouse!* A name that is instantly accepted as symbolic of reliability and dependability — the prestige of a mighty name still further enhanced by the qualities of the Westinghouse Dual-automatic Refrigerator. Consumer acceptance . . . and preference . . . prove that the Westinghouse is here to stay. For the Westinghouse Refrigerator is *right*.

Right in appearance, right in mechanical operation, right in all those worthwhile features that appeal to keen buyers. And right in its exclusive principle of Dual-automatic operation, fully automatic under all conditions.

For the user, Dual-automatic means double protection, double dependability, double value. For you as the dealer, it means dual power in your sales drive, and dual profit from a fair franchise and minimum service requirements.

If you are not selling refrigerators, or if you are not entirely satisfied with your present line, ask us about the Westinghouse dealer franchise. If you can qualify, you are assured of a complete line at competitive prices, that is adequately advertised, universally accepted . . . and here to stay.

WESTINGHOUSE ELECTRIC & MANUFACTURING COMPANY
Mansfield, Ohio

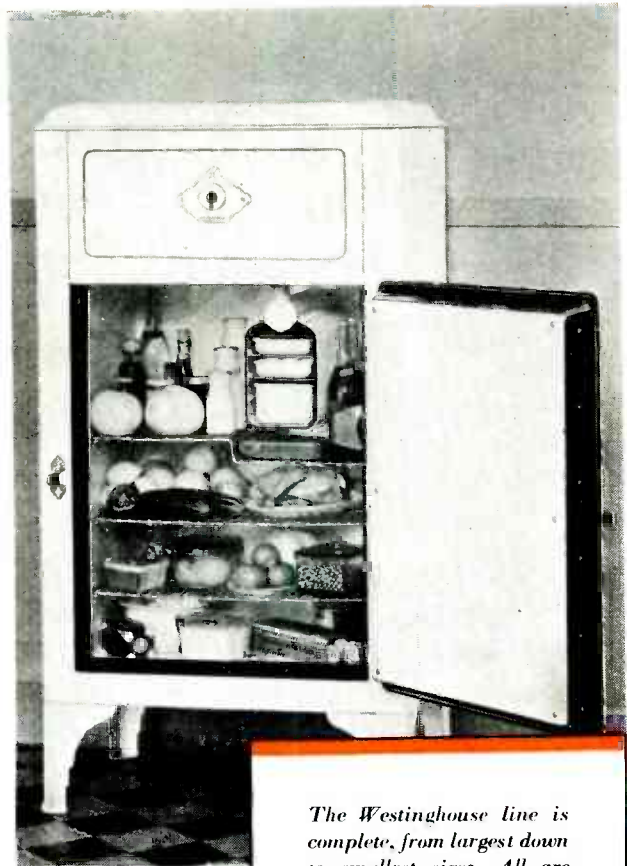

The Westinghouse line is complete, from largest down to smallest sizes. All are Dual-automatic.



Westinghouse

Investigate the beautiful new Westinghouse Water Coolers. Dual-automatic, striking design. Black Micarta cabinets, Chromium trim.



Model CMB-4 is portable for bottle supply. Equipped with lock compartment for bottled beverages. Without compartment, Model MB-5.

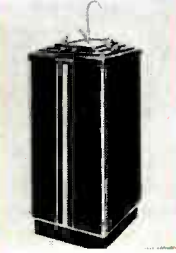

Model MT-8 is for water supply line, with bubbler and self-closing faucet. With refrigerated compartment, Model CMT-4.

Model 92—10-Tube SUPERHETERODYNE...distinguished high-boy, with Zenith Automatic Tuning and Tone-Totality. Complete with Zenith Quality Tubes, \$195.

Other QUALITY Zeniths from \$135 to \$290. Slightly higher in Far Western United States and Canada.



... that **VITAL**
margin of profit
imperative to
YOUR existence!

These days, when every sale **MUST** count...as never before...the shrewd radio dealer who features merchandise that gives him a wide profit and commands a price big enough for *such a profit*...plays his trump card for his own prosperity. Through outstanding superiority...through visible, *hearable* superiority...Zenith is the natural choice in the quality field. Zenith provides that **VITAL** margin of profit!



ZENITH RADIO CORPORATION

3620 IRON STREET, CHICAGO

FREE

The REAL Key to BIG TUBE SALES in 1932



IN Two Models — Complete with Full Merchandising Service — AT NO Actual COST TO YOU !!

ABOVE is shown the compact **COUNTER ANALYZER** for use where floor space is limited.

AT THE LEFT is shown the Aristocrat of ALL Display Analyzers—already a sensation in the trade—original, distinctive, compelling—the bright spot on the Dealer's floor—brilliantly illuminated Crystal Glass Showcase and shelving—genuine walnut cabinet by Adler-Royal. Interior display may be changed regularly. Plenty of room for complete tube stock in rear of mirrored display doors.

Tests all types, including rectifiers, and provides for future new types. Customers find it easy to read; easy to understand the meter readings. It builds confidence and makes sales.

ALSO

A CONSUMER MERCHANDISING SERVICE CONSISTING OF 19 DIFFERENT, TESTED SALES PRODUCERS

A PLAN THAT ENABLES YOU TO MAKE THE GREATEST NUMBER OF TUBE SALES WITH THE SYLVANIA ANALYZER

SYLVANIA'S TWICE WEEKLY BROADCAST over Columbia Basic Network—the **SYLVANIA** newspaper campaign—combined with this startling **FREE Analyzer plan**—warrant your interest and participation. Use the coupon for convenience.

Sylvania

REGISTERED U.S. PAT. OFF.
THE SET-TESTED TUBE

HYGRADE SYLVANIA CORPORATION,
Sylvania Division, Dept. R 12,
Emporium, Penna.

Please send me full details of the Free Sylvania Analyzer Plan.

My principal Jobber is..... City.....

My Firm Name

Address

City State.....

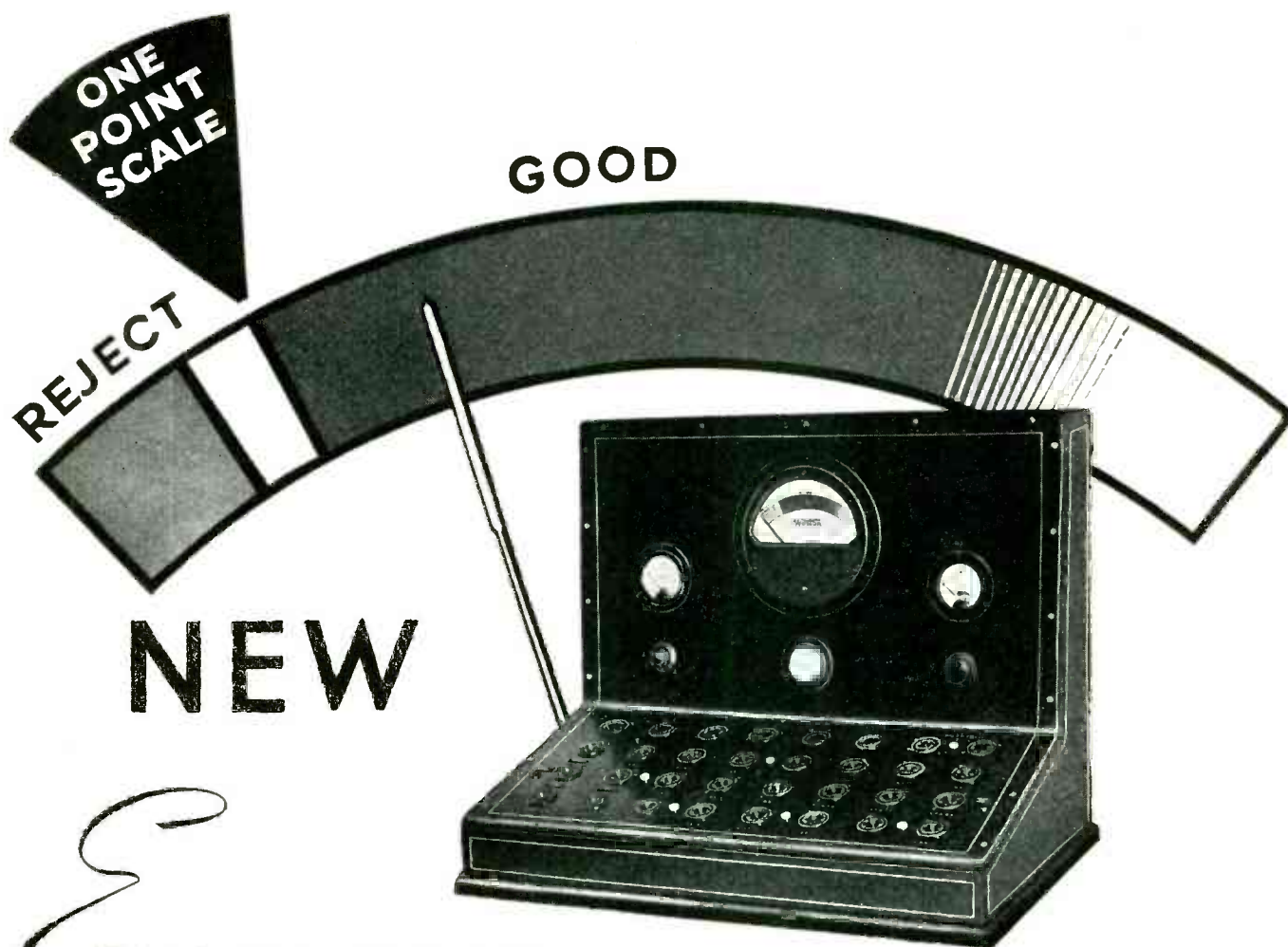

Easy TO READ

Easy TO USE *More Convincing*

Easy to read—for your customers as well as yourself. Easy to use—prevents errors and saves time. Two features of the new Weston Model 597 “Visual-to-Customer” Display Tube Tester that make its test more convincing to your customers . . . of vital interest to alert radio dealers who realize the sales-building possibilities in this type of tester.

Model 597’s “REJECT” or “GOOD” is clear, convincing—easily understood by your customers. No confusion . . . no explaining—a definite, unquestionable test!

Easy to operate—just insert tube, balance the circuit by turning *one* knob, press button to read. Simple and fast—anybody can do it.

Weston Model 597 operates on the “grid-shift” principle. To match set operating conditions, it uses graded plate, screen and grid voltages—automatically adjusted and applied when tube is inserted for test—an advanced, unique Weston feature. Individual sockets provide for each type receiving tube in general use. Six pre-heater and two short test sockets. Model 597 operates directly from any 90 to 130 volt, 60 cycle A. C. line.

Impressive in its ebony black piano-finish, reliable with its quality Weston construction, Model 597 Display Tube Tester is a paying investment—a real sales-getter that every progressive radio dealer would be proud to own.

WRITE TODAY FOR CIRCULAR B-1

WESTON

ELECTRICAL INSTRUMENT CORPORATION

581 FRELINGHUYSEN AVENUE

NEWARK, N. J.

BUGGIES



AND RADIOS

I HAVE been advised by the editor of one of the leading radio magazines that some eight thousand radio retailers have failed or disappeared from the business during the last eighteen months; and it isn't at all surprising when you analyze what the most of them are doing.

The first time I ever met Charlie Nash, now president of The Nash Motors Company, he was superintendent of the Durant-Dort Carriage Works, at Flint, Michigan; and in those days \$100 would purchase THREE BUGGIES. It isn't necessary to tell you what happened to the dealers handling those buggies. Nearly all of the eight thousand dealers who have passed out of the radio business have been trying to do business along lines similar to those followed by the carriage dealers, and are fast following in their footsteps.

When a prospect walks into a store, the majority of dealers immediately take him to the lowest priced merchandise in the store, with the result that ninety times out of a hundred the dealer never gets his customer away from that low priced merchandise.

Mr. Dealer, you cannot make sufficient profit out of \$25, \$36, \$45, or \$50 radios, or anything within that range, to warrant you in paying rent, light, heat, taxes, delivery service, clerk hire, and still have left for yourself a reasonable salary. All too many dealers are trying to do this very thing.

Sit down and think things over! Let those who wish to do so, deal in riff-raff, but for you, keep out of that class! Sell a merchandise that you are proud of, and at the same time make a margin of profit that will pay you for putting forth your best efforts.

THE SPARKS-WITHINGTON CO.
Jackson, Michigan

Great Artists *who will SELL*

				
LEO REISMAN	RUSS COLUMBO	WAYNE KING	PAUL WHITEMAN	JIMMY RODGERS
				
GUS ARNHEIM	TED BLACK	MILDRED BAILEY	JESSE CRAWFORD	FRANK CRUMIT
		<p>THESE names not only make sales for you . . . they make CUSTOMERS for you. Victor Records bring people into your store again and again and again. They also sell combinations for you. Call your RCA Victor distributor today.</p>		
VICTOR ARDEN	PHIL OHMAN			TED WEEMS
				
SYLVIA FROOS	FRED ASTAIRE	ADELE ASTAIRE	FRED WARING	BERT LOWN

RCA Victor

Radios · Records · Radio-Phonographs

RCA VICTOR COMPANY, INC. (A Radio Corporation of America Subsidiary), CAMDEN, N. J.

January, 1932

RADIO RETAILING

HOME ENTERTAINMENT MERCHANDISING

O. H. CALDWELL,
Editor

A MCGRAW-HILL PUBLICATION. ESTABLISHED 1925.

Bright Future *for* VISUAL ENTERTAINMENT

NO SINGLE factor for the coming year will affect more vitally the prosperity of the radio industry than that of the practical, commercial culmination of visual entertainment for the home. Television and home "talkies"—these are the devices that will start the dealer's cash register bell ringing again. What, then, of expectations along these lines?

Although clear, steady television images of fair detail and ample screen size are not at this writing available for Mr. Average Citizen, *Radio Retailing* has many reasons for asserting that one or more visual receivers, meeting these qualifications, will be on the market within the next six months. Already a 180 line screen, with cathode-ray tube projection, is in the advance experimental stage in at least three laboratories. The primary characteristics of such a system are greater detail, larger viewing surface and greater illumination of image. Furthermore, television projection from standard motion picture films and better sending equipment are imminent.

AND "sound-on-film" for home motion pictures also is entering a new stage of technical development. The writer has seen no less than three types of 16 mm. projectors which employ the light wave sound track on the film itself method. This newer process of synchronizing and reproducing the sound accompaniment will simplify immeasurably the present difficulties in the way of renting and maintaining home film libraries. Within the next three months it is expected that at least four well-known radio concerns will announce sound-on-film apparatus.

Only the merchandising advent of one or both of these major products—preferably television—will restore to the radio industry its former buoyancy.

This, then, is *Radio Retailing's* practical New Year's message: television and home talking movies soon will be on the market. Because of this, every man should tighten up his belt and take a fresh grip on his courage.

December, 1931

Looking

WE PREDICT

- Higher unit sales price
- Consoles will dominate
- New purpose tubes
- Bright outlook for practical television
- Sound-on-film home talkies
- Heightened activity in auto-radio set
- Short wave in popular demand
- A growing replacement market
- Intensive selling of refrigerators and other electrical appliances
- Longer playing records
- Further technical development
- Survival of the fittest—hence greater stabilization

The

Back
Dealer

I HAVE just
tacting deal
ferent states—
The one outstar
this personal ob
almost 200 repres
wide spread area
his head and carryin

True, the "margin
opportunist has, in n
of the picture, but
interest was, an
of courage wh
set maker
cies and
has h
tri

into 1932

Forecasting Merchandising and Technical Developments—Majority of Factors are Favorable—3,000,000 Sets Should be Sold

BOLD indeed is the prophet who ventures to predict what 1932 holds in store for the radio industry. In view of recent trends, however, and of technical developments which have taken place during the last quarter of the old year, certain deductions may be drawn.

The Set Business

Of first interest is the future of the set business. Based on preliminary reports from all the leading manufacturers, we estimate that 3,100,000 sets were purchased by the public during 1931. This includes 100,000 auto-radio outfits. From present indications, unless conditions change radically for better or for worse, this year should witness at least a similar number of unit sales.

It is now evident that the mantel model will not be a disturbing influence with respect to the sale of the better consoles. Where the difference in price between the small console and the better midget is not more than \$10, the console is winning out. The little table set seems to be finding its biggest market in the \$20-\$35 field and mainly in the larger cities. "Selling up" will be routine practice this year—and in most cases it will work.

It is rumored that the set makers are demanding, from the cabinet industry, lower prices on consolette cabinets. As a result we should see a closer price ratio between midgets and consolettes.

People are talking tubes. They are doing this because they weigh values these days. The 9 or 10 tube chassis will be much in evidence during the rest of this winter, and will appeal to a substantial class of buyers having approximately \$100 to spend for a real quality job. Practically all of these outfits will be furnished with automatic volume control. Closely related to the subject of selling better sets, in the \$100 price bracket, is that of the growing replacement market and the handling of trade-ins. These matters have been given special attention on page 22 of this issue.

Auto-Radio

Radio reception for motor cars will receive consideration this spring not only from those who manufacture radio sets but from the makers of automobiles.

A large majority of the set makers will be out with auto-radio equipment within the next three months. At least four types of converters, to do away with the unsatisfactory B-battery, already are in an advanced stage of development. This change, together with a new tube

designed especially for automobile service and described in the technical section of this article, will go far toward popularizing "music as we travel." Briefly, the converters about to be introduced are: (1) a high-voltage d.c. motor generator, (2) an a.c. generator, (3) a contact device for interrupting the d.c. from the battery and (4) an "inverter" using a vacuum tube of the thyratron type.

The list prices for complete auto-radio outfits will range from \$50 to \$110—with another \$20 for installation labor and material.

From careful field surveys, recently conducted, it is evident that, at present, responsibility of merchandising this item is shared equally by the radio dealer and the automobile or automotive supply dealer. Inasmuch as the radio dealer will treat automobile radio as a major activity he will be an important factor in cultivating this prospective market for 200,000 automobile receivers this year.

Short Wave

Short wave receiving equipment has been available to the radio listener for several years and has achieved some popularity. This year, however, a new factor enters the business. This new development undoubtedly will bring the lure of short wave shooting to a far larger number of set users.

The "converter" is a device which, when attached to a regulation receiver, converts it into a super-heterodyne which will tune in short wave programs. Although this business is just getting under way many dealers already have found that it has interesting possibilities. They have discovered that by playing up the ability of such an attachment to receive police reports, broadcasts from airplanes and from amateur transmissions, and by minimizing the facility of the converter to get, regularly, great distance, that prospects not only can be sold but that they remain satisfied.

There is something about the converter, as a piece of mechanism, which seems to appeal to that still existent army of buyers who like to "fool" with radio.

At least a dozen concerns now are making short wave instruments and many more will enter the field this year. So it is highly probable that the converter, as a built-in device in new combination long and short wave models as well as a separate article, will be among the more important of the 1932 accessories.

"All-wave" receivers, which tune from the very low wave length up to and including the broadcast band by

means of switching gadgets, also will give the live dealer a "set that is different," hence a very effective selling tool.

Eye Entertainment With respect to the progress of these two outstanding inventions for bringing "eye" entertainment into the home—television and the 16 mm. motion picture projector—we direct your attention to the editorial immediately preceding this article.

Electrical Appliances This forecast would be incomplete without some discussion of the part electrical refrigeration and other electrical appliances will play in the future activities of the radio dealer.

With many newcomers entering the ranks of those now manufacturing refrigerators—including a score of radio concerns—price competition will grow keener and lists may take a nose dive. Only a policy of intensive promotional selling—outside the store—well planned and aggressively executed, will meet this situation. The radio merchant must follow the methods of the specialty dealer. Specifically, based on the policies of one of the most successful refrigeration specialty men in America, these methods embrace the following fundamentals: Sixty-five per cent of major appliance sales come from

outside canvassing . . . Salesmen must have intelligent leadership . . . Predetermined quotas . . . Each hour of the salesman's day organized . . . Daily reports on all new contacts and repeat calls . . . Special incentives must occasionally be granted to keep production power at its maximum.

In a statement analyzing the outlook for the electric refrigeration industry in 1932, Louis Ruthenburg, chairman of the refrigeration division of the National Electrical Manufacturers Association, says: "In 1930 there were sold 770,000 household units. From figures now available it is apparent that 1931 business will exceed 1,000,000 household units, with a retail value of about \$290,000,000. Today there are approximately 4,000,000 homes equipped with electric refrigerators, while 21,000,000 are served with electricity. Because of this unsaturated market refrigeration sales for 1932 should exceed those of any prior year."

Loud Speakers A canvass of the speaker manufacturers brings this summarization with respect to reproducer trends: The next big advancement will be the use of two loud speakers per set. The prospect wants to actually hear the dollars worth of difference in sets being demonstrated. The use of two speakers, properly balanced, will make possible a real demonstration of comparative values.

About— NEW TUBES . . . CIRCUITS and OTHER TECHNICAL DEVELOPMENTS

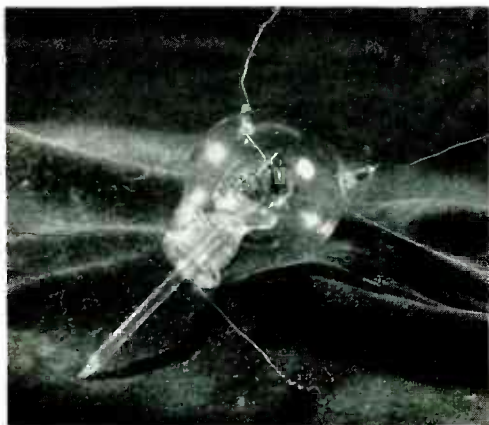

FOR 18 CM. TRANSMITTERS

Shortwave transmitting tubes are being developed for television as well as sound broadcasts. This one pushed 18 centimeter signals across the English channel. Special receiving tubes are also being designed for the higher frequencies

FROM a strictly technical standpoint new tubes will hold the center of the stage in 1932 for it is around these units that circuit design must evolve. Casting their shadows before, these electronic devices provide the basis for a general technical forecast.

The *super-control, radio-frequency pentode* designed for auto-radio should, for example, make it possible to build cheaper, more compact sets of this type, contributing substantially to the anticipated mobile radio boom. And it is probable that similar a.c. types will soon appear, for such pentodes have the extremely interesting ability to perform at low plate voltages with surprisingly little tube noise due to the reduction of secondary emission.

Tube makers are hard at work on a full-wave, *mercury-vapor rectifier* with a 2-volt, 3-amp. filament, capable of rectifying 400 volts at 80 mils. The tube, to be made with a bulb more nearly the size of receiving types, will have low internal resistance, constant with load, and hence may replace the type 80. Its better regulation will be particularly valuable where line voltage varies widely, in automatic volume control receivers and in connection with "class B" amplifiers.

This tendency toward *smaller tubes* may go farther, leading manufacturers to produce other existing types



AN "ELECTRONIC" SCANNER

Cathode ray tubes of this type will be seen in new television receivers. When proper voltages are applied the large, splay end of the tube becomes translucent, forming a screen

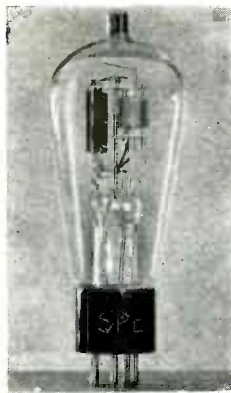

TWO TUBES IN ONE

The "triple-twin" has voltage and power amplifier tube elements directly connected within the one envelope. It is being considered by several set manufacturers as a possible successor to the pentode in a.f.

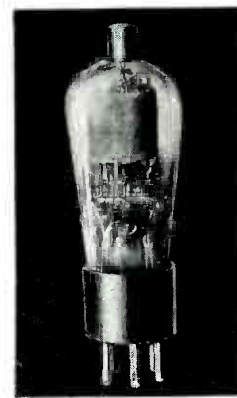

R.F. PENTODE

This variable-mu, radio frequency pentode is made for auto-radio but similar a.c. types will undoubtedly be developed during 1932. These will have far-reaching influence on set design

with "midget" bases and also smaller glass envelopes.

The laboratories have produced special transmitting tubes for the ultra high frequencies, which we gather will go to bat for television this year. These will have lower internal capacities and undoubtedly different element structure too as the distance electrons must travel within a tube is an important factor on the very short waves. And, we presume, if transmitting tubes are coming in for all this attention then shortwave receiving tubes are not being neglected by astute engineers.

From all reports *multi-mu tetrodes* will remain in favor as r.f. amplifiers with 45's and 47's continuing to struggle for a tactical advantage among audio amplifier designers. Type 24's, perhaps revised somewhat, will continue in popularity as detectors, in some cases being used as combined oscillators and detectors. And we pass along a rumor that certain manufacturers plan to use pentodes as triodes, tying screen-grid to plate, as a merchandising consideration.

Low-priced chassis will average 5 tubes and better models 10, as near as we can determine at this early date.

The palm for excellence of circuit design should undoubtedly be awarded to the gentleman who has found an important new use for *local-distance switches*. With the introduction of variable-mu tubes overloading ceased to be a problem but now manufacturers contemplate using the switch on better models to broaden r.f. amplifier tuning, thus materially bettering tonal response. Faithful amplification of frequencies up to 7,000 cycles may not be unusual in some 1932 receivers.

A "noise-bucking" circuit which automatically mutes tube and atmosphere noise when automatic volume control receivers are tuned from signal to signal shares the limelight and "spot-tuning" which makes it necessary to tune superheterodynes to exact resonance with a station if reception is to be obtained, thus making it impossible to spoil quality by cutting off sidebands, will be no less important when it is introduced. Both of these may be seen in May at the Trade Show.

Class B, or "push-push" audio amplifiers are already to be found in battery receivers, where their ability to provide a high order of amplification with low current drain is most needed. Scarcely a manufacturer has failed to investigate in this field and while we know of no a.c. receiver using such an amplifier at the moment it

is felt that with so many investigators anything might happen.

Permanent magnet dynamic speakers, known to engineers for some time, may reach the trade this year. Designers who have heretofore considered them solely for use in battery sets have discovered that by substituting such speakers for units requiring field excitation current power-packs may often be cheapened. Several laboratories are experimenting with cellulose acetate, which resembles photographic film, as a material for cones designed to respond particularly to high frequencies. Such cones would prove useful in *twin-speaker* jobs.

Several laboratories have designed new *auto-radio B-eliminators* and several types will probably be ready for the market shortly. Among the most promising is the permanent-magnet field dynamotor operating from the car storage battery, one of which is reported to be 50 per cent efficient, supplying 40 milliamperes at 180 volts. Then there are engine-driven double-current generators supplying both filament and plate current, rotary converters, "chopper" switches with step-up transformers and commutation devices to switch the current back to d.c. again and vibrators with rectifying devices.

Eliminators will probably range in price from \$15 to \$50, usually weighing less than batteries and taking up less space. Current drain on the storage battery, in the case of those devices energized from this source runs from 2 to 6 amperes. At present writing it is felt that the rotating types have the best chance of coming into general use at an early date due to the experience of many manufacturers with such equipment. In addition to the types described there are several inverters, using tubes, and also standard motor-generating units supplying 110 volt a.c. with which conventional a.c. sets may be operated.

Considerable work has been done on *television* in the last 12 months, enough to indicate definitely that electronic scanning will eventually supersede mechanical. One system which is rapidly taking shape uses tube scanning at the transmitter, and will operate in the vicinity of 7 meters in order to obtain the necessary band width, and may broadcast either 120 or 240 line programs with sound on a separate channel.

The receiving equipment now in experimental use with this system is super-regenerative, scanning being accomplished with a cathode-ray, fluorescent screen tube.

Sales 53% *to People*

Owners

*of old receivers are now
the best prospects says*

H. C. Zanglein

Rochester, N. Y.

*He contends it is cheaper
to obtain replacement
business than to
sell non-owners*

PEOPLE without sets have so far constituted radio's most important market. Even now, when there are actually more homes with receivers than without (30,200,000 families, 16,100,000 with radio) the trade continues to concentrate its sales effort on "new business."

Theoretically, 14,100,000 families remain to be sold. But no appliance, however universal, achieves 100 per cent acceptance. Some homes simply cannot afford sets, others have no need or desire for the service and may never be sold. And as the ranks of the non-users are thinned out by intensive promotion, selling costs in this field rise sharply.

It is not beyond possibility that replacements, this year, will exceed initial equipment volume. This, at any rate, represents the thinking of many dealers who have watched saturation increase. One such man, H. C. Zanglein, Hickson Electric & Radio Corp., Rochester, N. Y., plans to divert sales pressure from non-users to people with old sets in 1932. The following factors ac-

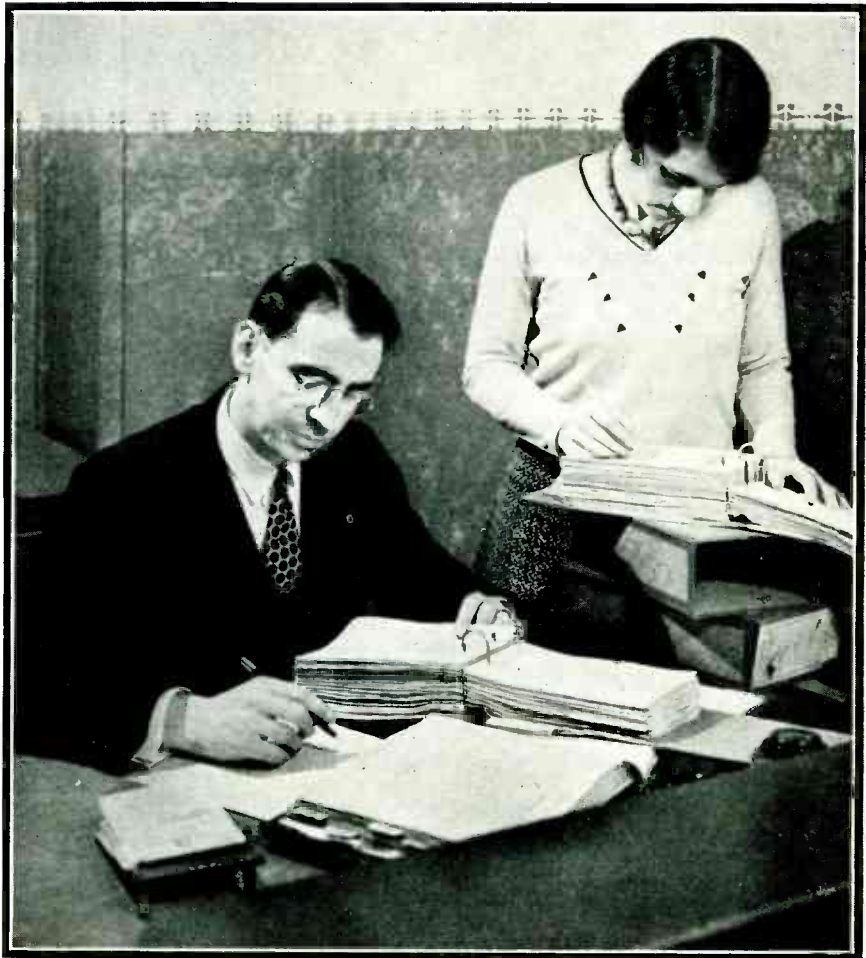

A session with the records showed Zanglein that sales to people already owning radios went from 32 per cent in 1930 to 53 per cent in 1931! So he is concentrating on users for 1932 business

count for this change in the store's merchandising policy.

(1) From July 1 to December 1, 1930, the store sold 92 radios, took 30 sets in trade. In the corresponding months of last year 106 receivers were installed, 57 taken in trade (unit sales were greater, dollar volume less). Inasmuch as the company's trade-in policy was not altered in any way, it is evident that at least 32 per cent of its business in 1930 was replacement, this increasing to 53 per cent in 1931.

(2) In 1930 the store's serviceman sold 6 sets while out on repair jobs and in 1931 (exclusive of December) he received commission on 31. This man made approximately the same number of customer contacts. His

By
W. W. MacDonald

with OLD Sets

greater success in selling was due to the fact that more of the old set owners upon whom he called had become prospects for new equipment.

In 1930 mounting service costs were looked upon as a necessary evil accompanying increased sales activity. In 1931 requests for service were welcomed as it became evident that they produced profitable replacement business.

REACHING REPLACEMENT PROSPECTS

ZANGLEIN sensed the increasing importance of replacement business several months ago and made a definite effort to get more of it. During the summer he conducted a prize contest over station WHEC (until recently owned by the store but now separately incorporated) ostensibly to locate the oldest receiver in the city. The announcer invited listeners, twice daily for ten days, to send in the trade names and model numbers of their sets. The owner of a 1920 heirloom won the prize, a new console, and his set was placed in the window of a local bank to further focus attention on the Hickson obsolescence drive.

Although more than 400 letters were received from people with old sets, 57 of these being classified by the sales department as good replacement prospects, the contest's sponsor does not feel that it was a success. He believes the idea to be basically sound, will repeat it again in the near future with these improvements: The next contest will be announced for a full month, and at the height of the radio season. It will be backed up by newspaper advertising, if for nothing else than to get the company's name on paper (many listeners evidently heard the announcement but failed to record the address of the store). The award will be made from the stage of a local theatre, some sort of a cooperative arrangement with the management. Under proper conditions at least 5,000 letters should have been received, we were told.

Another method: Three years ago 80 per cent of the store's business was in one make of receiver. All sets of this make on the books, therefore, could be classified as old. A list of the owners of these models has just been given to the concern's salesmen with instructions to follow up periodically for new business. It is too early to judge results

The National Picture

48.5% of the 3,100,000 Sets Sold
in 1931

Went to Homes Already Owning Radios*

Relatively few of these were "second set" purchases, most of them involved trade-ins

*"Radio Retailing" survey, Dec., 1931.

but this group will undoubtedly contribute much toward the 1932 sales total.

The girl who receives telephoned requests for service and the service-man, have been requested to make special note of the model numbers and trade-names of sets which are obviously several years old. This information is turned over to the sales force, with any other details concerning the age of the set, for follow up. Where the serviceman unearths a prospect but cannot close a sale he turns the lead over to a salesman and splits the resulting commission.

Other ways of appealing particularly to the users of old receivers will undoubtedly develop during the year. Zanglein points out that several manufacturers, in order to clear out stagnated stocks, are offering increased discounts which may make it possible to put on a special trade-in offer without jeopardizing net margin.

Advertising will be directed largely to users rather than to non-users. "Toothpaste manufacturers have long since stopped advertising how wonderful it is to use toothpaste and stress, rather, the fact that users may have cleaner teeth through the use of their particular



One way of clearing out trade-ins: Hickson Electric puts the chassis in \$16.25 electric clock cabinets, sells the combination for \$69.50

(Please turn to page 49)

When the Navy Hit Davy Jones' Locker

Aboard a submarine during an underwater broadcast. Announcer George Hicks' words were carried from the U.S.S. O-8 to the O-4, on the surface, and then transmitted by short wave and wire to the NBC control room at New York



The Costs

The Romance

The Disappointments in

Putting BIG NEWS



When Bobby Jones Won the Championship

The need for field broadcasting resulted in the development of a portable short wave transmitter by the National Broadcasting Company. Used for the first time during the broadcast of the American Open Golf Championship, Cleveland

WHEN your customer is sitting at home in his living room listening over his radio to a description of a football game, an aviation meet or a tennis match, or to a talk from England or France, does it occur to him that sometimes weeks, even months, may have been spent in preparing for a broadcast that may take but fifteen minutes? If he knows about this, would not his radio set mean a lot more to him?

And does he know that Nature sometimes plays queer, mean tricks which upset the months of planning of radio executives? Not by upsetting any technical arrangements, but by marring the events scheduled to be broadcast.

The business of broadcasting the outstanding news events from the four corners of the earth is an exciting one, yet one that has its heartaches and its headaches. If you don't believe this, ask the men of the big chains who are in charge of "news broadcasting."

Mrs. and Mr. James Brown turn on the radio and hear a voice from a dirigible sailing along the Atlantic coast. They little realize what intricate preparations have made the special broadcast possible.

The whole country was enabled to follow the first flight of the giant Akron as a commissioned ship of the United States Navy. That program reached the listeners as a result of months of negotiation and preparation by officials of the broadcasting companies.

The Browns and their friends, when they "caught" the "attack" of 672 planes on New York City last Spring, undoubtedly didn't realize that broadcasting technicians



When Yale Played Harvard University

Ted Husing, Columbia announcer, and his observer, Les Quaile, covering a "big three" football game. It was at this affair that Ted spoke out in meetin' and made front page news

When Post and Gatty Flew Around the World

The arrival of Post and Gatty at Roosevelt Field, L. I., after their record-breaking, round-the-world flight, was the occasion of one of the most thorough jobs of radio reporting to date. Floyd Gibbons is in the center



FEATURES *on the Air*

had worked and tested for many weeks to perfect the complicated broadcasting arrangements.

WHY PREMIER LAVAL DIDN'T SPEAK

ANY special event, especially when it involves tying up many widely-separated points in a smoothly running broadcast, requires a tremendous amount of advance work. And then sometimes, after weeks of preparation, unforeseen contingencies spoil the most carefully laid plans.

Weeks before a chartered tug steamed out to meet the *Ile de France*, 100 miles off shore, and there have Premier Laval broadcast his greetings to America, it had been necessary to obtain permission from six governmental agencies. Finally the tug, guaranteed to do fourteen knots, puffed out through the Narrows. But it was soon apparent that her speed had been over-rated. As a result, the Premier's ship was not reached until almost midnight, and he had retired. The weeks of preparation and negotiation, as well as considerable expense, had gone for nothing.

PLANNING SPORTS BROADCASTS MONTHS AHEAD

SPORTS broadcasts also require month's of planning. In the Columbia System the task of H. B. Glover is to select the events and the duty of E. K. Cohan is to supervise the technical arrangements. Neither is an easy job.

Even before the 1931 football season had drawn to a close, Ted Husing and Mr. Glover began laying plans for broadcasting what they believe will be the outstanding gridiron classics of the 1932 season. They must go over carefully the 1932 schedule of the colleges and universities throughout the country. They must examine the list of 1931 players who will graduate and must try to estimate the strength of the teams for 1932 so that they may determine as nearly as possible which teams will be the best during the 1932 season.

When this has been done, permission must be obtained from the various institutions of learning to broadcast the games. This accomplished, the engineering department, under Cohan's direction, begins to lay plans for "piping" the descriptions of the games to the network. It is a long, hard task—this business of scheduling football broadcasts.

For the first time in history Olympic Games will be broadcast in 1932. For more than a year executives of the Columbia Broadcasting System have been laying plans for description of the winter games which will be held at Lake Placid from February 4 to 13, inclusive, and for broadcasting the track and field events to be held on the Pacific Coast during the summer. Engineers spent several months at Lake Placid preparing for the winter sports broadcasts.

In order that radio listeners might obtain the most nearly perfect picture possible of golf matches, Columbia engineers designed a special portable short-wave transmitter. This is strapped to Husing's back, and he follows

the players all over the golf course. His description is picked up by a receiver in the club house and sent by land wire to the New York studios of the Columbia Broadcasting System, whence it is piped to the stations of the network.

A MULTI-POINT AVIATION FEATURE

PROBABLY the greatest multi-point broadcast ever staged was that put on by the National network in connection with the air maneuvers over New York. Perfect second-by-second coordination between announcers and engineers was required. Seven announcers took part, two in planes and five in strategic positions along the line of flight.

Director Miller, seated before a special portable control board, tied the whole show together. Through special short-wave equipment, he told each announcer when to go on the air and when to give way to another. Thus a running account of the dramatic "attack" was kept up, switching from Mitchel Field to Valley Stream Airport, to an Army transport plane, to the roof of a building in upper Manhattan, to the top of the Empire State Building, and back to an Army command plane. The story kept coming, but its source kept changing, with never a moment's delay.

Miller often works six months to a year ahead in planning special broadcasts. He is already preparing for the National Conventions which will choose the presidential candidates for the election next fall. Secretaries are making thumbnail sketches and collecting anecdotes concerning every man who might conceivably be prominent in the two conventions. These will be for the use of announcers, so that as soon as a man gets up to speak, the announcer will have something at hand about him.

The Winter Olympic Games at Lake Placid are also engaging Miller's particular attention right now, and tests are under way. One stunt he plans is to send an announcer down the mile and a half bob-sled run with a portable short-wave transmitter which will enable him to describe the thrill for millions of listeners. For this bob-sled ride, which will take approximately two minutes, the special wire lines alone will cost \$1,600, but the NBC will feel itself well repaid if it can get the thrill over to its audience.

BY SHORT WAVE FROM EUROPE

THE broadcasts from other continents require extensive technical preparations. When a European statesman broadcasts from his capital to America, in the Sunday series of international programs scheduled regularly on the WABC-Columbia network, two high-powered transmitters employing four different wavelengths are used to span the Atlantic, and two receivers are used on this side of the Ocean to pick up the signals before they reach Columbia's master control room in New York.

A speaker from England, such as Sir John Simon or Viscount Cecil, addresses a microphone in the London studios of the British Broadcasting Corporation. For the Sunday broadcasts at 12:30 P.M., EST., there is no English audience, as the events are specially arranged for the American network. In many cases, however, Columbia rebroadcasts addresses which form part of the "B.B.C.'s" programs, and then there may be as many as sixteen stations linked in the British network.

From the B.B.C. master control room the signals are passed to the long-distance department of the British Post Office telephone service, regardless of whether the program is to be sent to British stations also.

From the London telephone headquarters they are relayed to Rugby, where the transmitters are located for transoceanic radio-telephone. The impulses are passed to four transmitter antennas, three operating on short wavelengths, between fourteen and thirty meters, and the fourth on five thousand meters, and radiated simultaneously towards the United States. All of the antennas are directional, so as to obtain the maximum possible efficiency with the power input used.

At Netcong, N. J., the American Telephone and Telegraph Company has a number of receiving antennas, also directional, and pointing towards Rugby. These are specially constructed for short-wave work of this kind. The signals which they pick up, greatly weakened in power after crossing the Atlantic, are amplified enormously, and passed by land wire to the long-lines headquarters of the A. T. & T. in New York.

The long wave signal, on five thousand meters, is not received at Netcong, but at Houlton, Me., where special equipment for work on this wavelength is installed. Reception on this channel also is piped down to the long-lines office, so that four different signals are being received there simultaneously. The best of these are selected and relayed to Columbia's master control room on Madison Avenue.

From this point the American distribution begins—to WABC's transmitter; to the short-wave station, W2XF, and to the line which joins the eighty-eight stations on the network.

If the pick-up is to be made on the continent of Europe, studios of the local broadcasting service generally are employed—those of the French government system in Paris, and of the Geneva broadcasting station for League of Nations events. From these points the signals travel by land line to London, before being passed on to Rugby for transmission in the usual way.

NATURE STEPS IN AND RINGS DOWN THE CURTAIN

OFTEN Nature plays queer tricks on the broadcasters.

Months of preparation went for naught when Columbia prepared to broadcast the bombing of the condemned Shipping Board freighter, "Mount Shasta," by the Army Air Corps some seventy-five miles off the Virginia Capes last spring. As far as short-wave broadcasts are concerned, Columbia engineers performed what is considered one of the best jobs in the history of radio when they successfully picked up Ted Husing from the deck of the Army mine planter which carried the announcer and official Army observers. The pick-up was made from the roof of the Cavalier Hotel, at Virginia Beach, and fed into the system through WTAR, Norfolk.

On the first attempt bad weather prevented the bombing planes from ever reaching the spot, and on the second attempt the bombers succeeded in reaching it. They dropped all their bombs but failed to sink the "Mount Shasta," thus causing disappointment for the radio technicians who had spent many days and nights building special equipment and testing it.

But the headaches and heartaches and the expense mean nothing to the workers if the broadcasts are not marred by Nature.

Best Outlet for Auto-Radio? **Radio Stores!**

s a y s

Frank Beaucaire

*Beaucaire & Mitchell, Inc.,
Rochester, N. Y.*

*Most Car Dealers and Salesmen Are
Too Busy With Their Major Line To
Bother With Any Accessory Right
Now, According To This Distributor*



AUTO-RADIO is gathering momentum. From every side we hear that it is going places in '32. The trade regards those sets which have been sold to date merely as consumer "samples." Now it is preparing to achieve worthwhile volume, working out the knotty problem of distribution.

The question that still puzzles is: Which is the best immediate outlet—radio or automotive dealers. On this subject Frank Beaucaire, Rochester, N. Y. radio distributor who has been selling auto-radio for a full year, contributes the following interesting observations:

"At present radio dealers are our best accounts, despite the fact that they must laboriously ferret out prospects. We offered "Transitone" last January to 140 stores, of which 104 were primarily radio and 36 automotive. Today we have 35 who may be classified as active, having repeatedly re-ordered—and 28 are radio outlets. The others are tire stores, speedometer and shock-absorber specialists, with one battery service shop.

"Car dealers, theoretically, are ideally equipped to sell auto-radio and many eventually develop into important outlets. They are not yet factors in this district, however. As I see it, their salesmen are too busy scratching for automobile business to bother much with any accessory right now. Many showroom managers discourage the installation of radios in demonstrators as they feel that prospects become interested in the performance of Bing Crosby rather than that of the car.

"Our few active automotive accounts are those experienced in specialty selling. Auto-radio in my estimation, is a specialty and as such is best handled by specialty houses accustomed to selling by intensive methods. It

is not an accessory to be sold over the counter and this may account for the failure of most general accessory stores to do a job at this early date. What auto-radio needs most at this instant is more dealers to push it as a major activity."

SOME light on the present status of auto-radio business in Wayne, Monroe, Livingston, Ontario and Yates counties:

"Our particular sets are installed and serviced for all dealers by 10 specializing organizations, these charging a flat-rate for such work. The service station advises us when a dealer has a set installed and we collect the charge, later remitting to the shop providing the labor. No dealer, radio or otherwise, is permitted to install an auto-radio purchased from us as we feel that installation by an expert is essential. Dealers are, for this reason, selected for their ability to merchandise rather than render service.

"Fully 90 per cent of the sets are sold on time but volume has not been great enough so far to force dealers to secure outside financing aid. We have, however, worked out a non-recourse, no-holdback plan with a local finance company which will be available when volume warrants its use. This plan will permit the trade to safely accept low down payments."

With reference to current sales methods:

"Several dealers report excellent results from circularization of local car owners. Others pin their hopes to intensive promotion among old customers known to have cars. All lay particular stress upon the value of demonstration equipment in their own and company cars."

*This
AD
Sold...*

**Benesch & Sons Unite With Philco
In Making This Great One-Day Radio Offer**

PHILCO Day

\$1 Delivers PHILCO RADIO TODAY Only!

ALL NEW 1932 MODELS

Philco Factory Engineers Will Be At Our Store Today. Ask Them About Your Philco

BENESCH Easy Terms Lead Them ALL

A Model For Every Home and Purse

36 Powerful 5-Tube Set

49 Midget

49 Console

65 Console

189.50 End-table

189.50 Clock

189.50 Lowboy

189.50 Radio

189.50 Philco Low Boy Model

189.50 Philco High Boy

Benesch & Sons
431-33 Hamilton St., Allentown

Leave To Our Organ Program This Morning
11 P. 1.15 A. M.—Boston WGBA

... 104

ON Friday, Dec. 4, P. P. Letcher, manager of Benesch & Sons branch store at Allentown, Pa., took a full page in an evening paper to announce a one-day radio sale. Five models priced under \$90 were advertised, the company adhering to lists but offering the sets at \$1 down.

The ad was repeated on Saturday morning (the two cost \$180) and was supplemented by a 15-minute broadcast over WCBA. At the end of the day these sales were recorded:

\$49.50	Midget	25
49.95	Consolette	11
65.75	Console	35
69.50*	End-table	13
89.50	Clock	3
89.75*	Lowboy	17

*Not advertised, larger down-payment obtained.

In conformance with store policy no trade-in allowances were made, no home demonstrations were conducted and no outside salesmen employed. Free delivery, installation and 6 months' service was included with each set. There were no finance or carrying charges.

Heightened store traffic (radio represents only 10 per cent of the volume) was also reflected in increased furniture sales.

The foregoing report prompted several questions concerning the Benesch organization and its methods, which Mr. Letcher, interviewed by a "Radio Retailing" editor, kindly consented to answer:

What accounts for such response to two ads?

"The attractive terms, coupled with the fact that we played up inexpensive models in our advertising just before Christmas, was largely responsible. We had offered midgets before at \$1 down, but never consoles. The presence of factory 'engineers', really servicemen and salesmen, helped.

"Our name had much to do with it. There are 30,000 customers on our books who watch the papers for Benesch specials."

How can you afford these low down-payments?

"We are set up to do a credit business, handling all our own paper and 90 per cent of our sales are on this basis.

It would be no hardship for us to extend payments for two years, for example, although this is not necessary in radio due to the low unit price of sets.

"You will notice that with the exception of the clock model (included in ad to give it 'color' rather than in anticipation of volume) sets offered at \$1 down listed below \$70. Practically all merchandise purchased on special terms during the campaign will be paid for within one year. And it is interesting to note that our salesmen sold 30 models, valued at \$2,429, which were not advertised, obtaining higher down-payments on these.

"It has always been our policy to consider a man's credit rating rather than the size of his down-payment. Have you ever heard of a real estate dealer turning down a buyer with a AAA1 rating just because the customer wanted to conserve cash?"

Won't your credit losses increase?

"Safety in credit work is a matter of checking prospective accounts carefully. Allentown dealers are fortunate in that they have access to 200,000 names at the local credit bureau. (Letcher is on the Board of Governors.) Much of our business is transacted with old customers, which also helps keep losses down. Fifty-six of the 104 radio buyers attracted during our sale, for example, were already on our books. We have approximately 12,000 active credit accounts. Seven prospects were rejected during the campaign as poor risks.

"Credit experience is another essential in a business such as ours. The original Benesch store, established at Baltimore, Md., 81 years ago, was the second credit furniture house in this country, Cowperthwait's of Brooklyn, N. Y., being the oldest. The Allentown store's credit losses are less than 1 per cent."

Why weren't more midgets sold?

"This concern has been 'selling-up' since the Civil War. It has always been our practice to feature low-priced merchandise in our advertising to attract trade and then to sell them better equipment when they arrived. The fact that our customers buy on time makes it easier for us than for the average dealer. We stress the slight difference in the amount of the monthly payments and play down the difference in lists.

¶ *Pre-holiday campaign featuring terms produced
\$6,797 Saturday radio business for Benesch &
Sons, Allentown, Pa., credit furniture house*

SETS *in One Day*



P. P. LETCHER

“ . . . forgot about the depression”

“Midgets saved our radio business in 1931 by giving us something to advertise. We splashed them over every radio ad and then proceeded to sell better sets. Sales totalled 1,504 receivers, averaging \$71.

“A \$36.50 midget played an important part in our Saturday campaign, attracting many buyers, but not one was sold. As a matter of fact we have had six of these sets in stock since last August and have used them as leaders consistently, without selling one. Our 5 salesmen, who work on salary and commission in the store, were told when these sets were taken on that there would be no commissions on them.”

Have you ever tried direct-mail?

“Despite the fact that we could build up an excellent mailing list we think the newspaper is the place to spend our money. Saturday’s broadcast was one of our few exceptions. Benesch furniture ads run daily in an Allentown morning paper and radio is featured at least once a week. It is our policy to advertise consistently, rather than to spend all our money in one grand space orgy. We will, for example, advertise radio again within a week after Christmas and will continue to advertise it at least weekly thereafter just to keep before the public.

“During July and August, when most stores of our type permit special furniture sales to crowd radio from their advertising pages, we merely give it less space, proportionately, and continue to run it. Consistent advertising, year in and year out, is one of the chief factors in the success of this organization.”

How do you avoid demonstrations and trade-ins?

“We have never put a radio out on demonstration, in fact have rather poor facilities for demonstrating even in the store. Because we have a substantial furniture trade on which to draw for radio business we are probably troubled less than specialty outlets in this respect.

“Our customers apparently assume that Benesch exercises the same good judgement in the selection of a radio as in the selection of other articles of furniture and that any article purchased of the store will give satisfaction. We strengthen our position by being extremely liberal when adjustments prove necessary.

“It has been our policy to refuse trade-ins and so far there has been sufficient ‘new business’ to permit this. It is my personal opinion, however, that the day is not far off when all radio dealers will find it necessary to make trade-in allowances in order to obtain volume.”

"Arm Chair" Control



This Brighton, N. Y., home has the latest in radio convenience — a dial-less receiver plus portable tuning units, concealed wiring and remote speakers

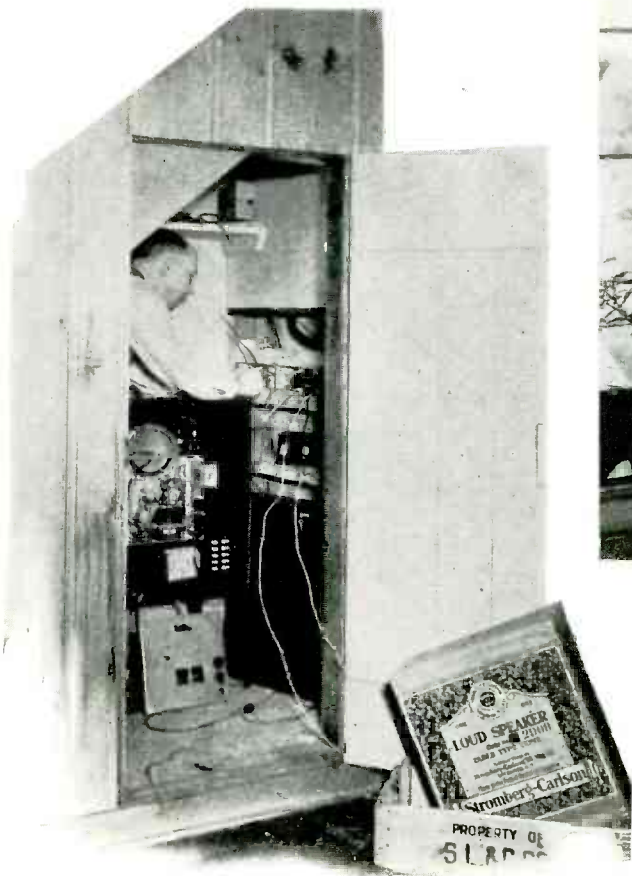

In the living room, a speaker is concealed in the paneling. A plug-in, portable unit (which may be seen beside the cone) provides push-button, automatic control of eight stations and silent, visual tuning for others

The dial-less receiver was set up in a closet under the cellar stairs. Intercommunicating telephone cable, containing 30 wires, snaked through the walls to each tuning control position while a 5-wire cable feeds remote speakers

FACTS AND FIGURES

Sibley, Lindsay and Curr, Rochester department store, sold the equipment

	Sibley Paid	Customer Paid
1 3.2 watt receiver in steel locker cabinet.....	\$144.00	\$240.00
1 "Telektor" motor unit.....	57.00	95.00
1 Transformer for matching speaker impedances.....	6.00	10.00
1 Speaker with relay, tube and rectifier.....	34.35	57.25
3 Cabinet type speakers with tubes and relays.....	153.00	255.00
3 Tuning control boxes, with 10 ft. flexible cords.....	54.00	90.00
300 ft. lead-covered cable for wall wiring.....	72.00	108.00
1 Terminal box.....	3.33	5.00
1 Cable between receiver and wall outlet plate.....	6.00	9.00
5 Four-gang combination outlets.....	46.67	70.00
1 Speaker outlet.....	5.50	8.25
1 Control outlet.....	4.20	6.30
1 Outlet for remote phonograph*.....	5.00	7.50
1 Special outlet at phonograph location*.....	4.00	6.00
	\$595.05	\$967.30

**Automatic phonograph unit to be purchased later.*

Cost of installation (Stromberg-Carlson) by Wood Radio & Electric..... **175.00**

TOTAL COST..... \$1,142.30

"Fanning" cables at a junction box in the basement, where rectifier and relay for the living room speaker are located. In this case the architect insisted upon the use of approved outlets and Greenfield although all control circuits carry only 25 volts a.c. hence pass without conduit as "door-bell" wiring

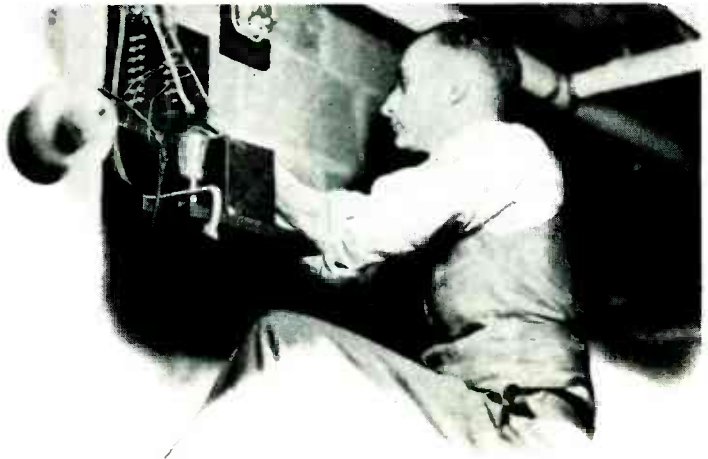

"Junior's" room has one of the cabinet speakers. Daddy can turn the radio on or off, tune it, connect or disconnect any speaker from any control position, including the master bedroom



Radio's BIGGEST

"Radio Week," Chicago, advertising.. Enlists support

THE cost per wholesaler was ridiculously small, less than \$20, while the actual cost of the publicity, if purchasable, would have run not less than \$100,000."

This statement, by the general chairman of the Chicago Radio Week committee, gives but a preliminary picture of the success which attended this remarkable cooperative campaign, concluded Dec. 5, and which entitles it to be called, "Radio's Biggest Publicity Splurge."

Last month, pages 24-25, we reported the first, or parent, campaign for publicising the worth of radio programs and the wisdom of buying only a *quality* set. This idea originated in Detroit. To get the general principles underlying a plan whereby the services of so many powerful publicity agents can be enlisted, practically without cost, to boost for radio, we suggest that you review this article.

Now Chicago goes Detroit one better. Here are the highlights of a real promotional job... engineered by and for the radio trade:

6 Big Newspapers

The complete cooperation of all six Chicago newspapers was secured in preparing and publishing promotional advertisements, stressing the value of owning a modern radio and the necessity for having up-to-date equipment in order to receive properly the wonderful programs being broadcast. Front page boxes, full page ads, half page ads, teasers, cartoons, pictures, etc., were the order of the day for Chicago newspapers. Approximately 12,000 column inches of promotional copy, news stories and advertising were featured in these papers during the Radio Week observance.

In addition to the newspaper campaign itself, all of the newspaper trucks carried posters on the sides calling attention to Chicago Radio Week. One newspaper started a special serial story called "Station L-O-V-E" to tie in with the event.

14 Broadcast Stations

Fourteen broadcasting stations got behind Radio Week idea, making frequent spot announcements regarding the value of radio, the quality of transmission their station was putting out and the necessity for having a good set to "cash in" on this service. At least \$10,000 worth of free publicity on the air was secured.

Theatres and News Reels

Here's a new publicity stunt which can be used by any live bunch of radio dealers, apart from its connection with Radio Week:

A large number of the leading retailers in Chicago donated their traded-in sets to a central organization. These sets were re-conditioned free of charge by Lane



NEWSPAPERS

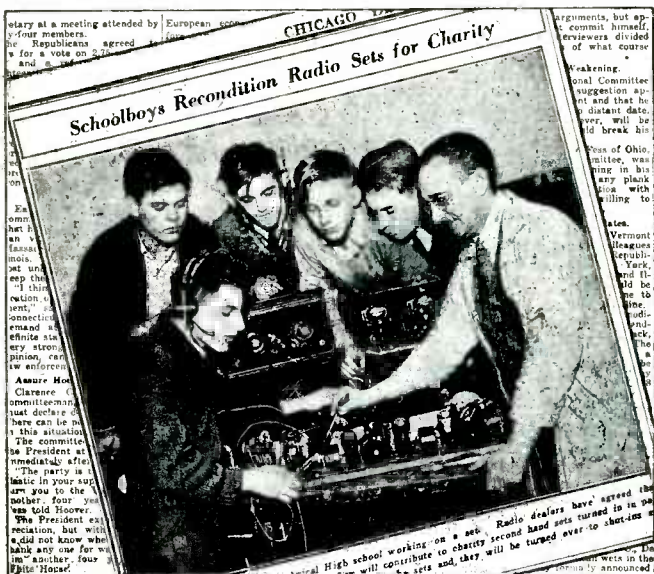

DEALERS

PUBLICITY Splurge

gets \$100,000 worth of
of 47 publicity agencies

Technical High School students. They then were distributed to various charitable institutions and needy homes throughout the city.

The first distribution took place with Ted Healy officiating as master of ceremonies. Pictures of this event were taken by the news reel concerns. The Fox Movietone Company used the film in two releases. The first release was for neighborhood theatres in Chicago and headed "Chicago Radio Dealers aid Santa Claus by giving Traded-in Sets to Poor." The second news reel was used in approximately forty theatres in the city and was headed "Here is a good use for your old Radio."

Window streamers and posters as well as truck broadsides were furnished free of charge to all radio distributors and dealers throughout the city. Open house and special store displays prevailed throughout the two-week's duration of this activity.

Clubs, Cafes, Dance Halls

The cooperation of 24 of the leading dance bands in the city of Chicago was secured in making mention of Radio Week in their programs at the various clubs and restaurants. The Music Corporation of America provided cards for each table, stating that the leader of the band in that cafe heartily endorsed Radio Week and would play any number that they had heard over the air by request, simply fill in the card and turn it over to the waiter.

In this wide-flung campaign Chicago's two largest ballrooms played an important part. The Trianon and Aragon provided exhibition booths for each distributor. Consoles, only, were displayed. Price tags and promotional literature were barred. Approximately 75,000 persons viewed these exhibits. Thursday night, Dec. 3, leading radio stars made personal appearances at each ballroom. At this time 24 sets were given away. "Uncle Bob" was master of ceremonies at the Aragon and Quin Ryan officiated at the Trianon.

But the outstanding event that evening was the selection of Radio Queen of Chicago. Both ballrooms previously had conducted many "auditions." Ruth Wenter, a Northwestern co-ed, was the lucky girl. She will make personal appearances, under the auspices of radio trade associations, in Milwaukee and other nearby cities.

In the opinion of all the leading radio wholesalers and dealers of Chicago, "Radio Week" did more to stimulate business than any other one radio event ever held.

Plans for a National Radio Week, modeled along similar lines, are now well under way. If this idea materializes it will, of course, be held under the auspices and direct guidance of the National Federation of Radio Associations and the Radio Wholesalers. A complete report of the Chicago affair will be made at the Sixth Annual Convention of these two bodies, to be held in Chicago, January 18-20.

CHAIN HEADS APPROVE
The presidents of the two large broadcasting chains, M. H. Aylesworth of the N.B.C. and William S. Paley of the C.B.S., whose organizations have worked hard and spent large sums of money to perfect transmission, welcome Radio Week as a means of disseminating a fine program is frequently heard. Here is what they say.

WIDE APPROVAL EXPRESSED FOR RADIO WEEK IDEA
Heads of NBC and CBS Are Enthusiastic Over Movement.

Chicago Radio week now being celebrated has elicited hearty approval. H. H. Aylesworth, president of the National Broadcasting Company, wired the Chicago Radio Week officials as follows:
"As president of the National Broadcasting Company, I heartily commend the action of the radio dealers and distributors in Chicago in promoting Chicago Radio Week. I believe this is to be one of the fundamental moves in the direction which leads to the return of prosperous times. I sincerely hope that the general public will soon be able to enjoy the benefits of this movement."

BROADCASTERS

Chicago Radio Queen Picked at Ballroom Auditions
BY CHARLES J. GILCHREST.
Chicago chose its radio queen last night in connection with the observance of Chicago radio week. She was chosen from the hosts of amateurs and professionals who took part in the auditions at the Aragon and Trianon ballrooms, where radio balls were staged. The radio queen is RUTH WENTER, an amateur singer of the Kappa Kappa Gamma sorority at Northwestern University. Second and third places went to VIRGINIA CLARK and SELMA SHAPIRO, respectively.

SPONSORS PLAN RADIO BALL AS FEATURE HERE
Event Will Be Highspot in Week Devoted to Advancing Benefits of Air.

CHICAGO RADIO WEEK
NOV. 30 TO DEC. 6

BALL ROOMS

Spend a DOLLAR

Even for eliminating deep scratches the materials required are inexpensive and easily obtained. They are itemized in the text below. The shirt-sleeved gentleman is GEORGE WEISS, Aeolian Company, New York, who helped prepare this article

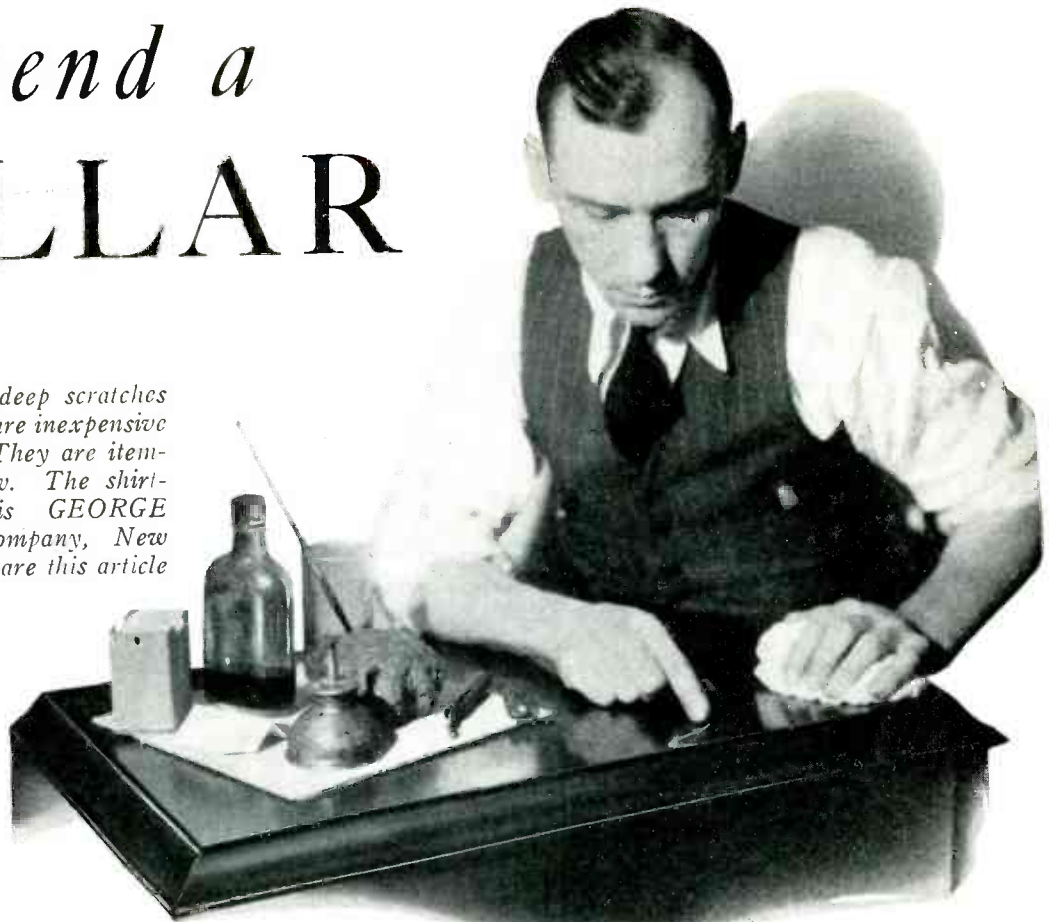

THE average radio dealer can repair 80 per cent of all radio cabinet surface defects himself, even though he knows but little about the art of wood finishing. He can make his sets look practically as good as new at an initial cost, for materials, of not more than a one dollar bill.

When one considers the cost of complaints, of returning consoles to the factory, and of having unsightly woodwork spoil the chances of a sale, one wonders why all dealers do not spend this dollar, practice up a bit, and become their own cabinet refinishers.

No less an authority than George Weiss, head of the "get-ready" department of the Aeolian Company, and a cabinet craftsman of wide experience, is responsible for the preceding remarks.

According to Mr. Weiss there are five kinds of damage to fine woodwork finishes which generally can be repaired by the dealer: press marks (bruises due to improper packing); scratches (deep and surface); dents; rubbed edges and fractures.

The tools and materials required by the refinisher are:

Quart bottle of crude oil thinned with benzine— $\frac{2}{3}$ oil, $\frac{1}{3}$ benzine	\$0.15
Furniture glue	.10
Steel wool, very fine	.10
0000 pumice stone powder	.10
Walnut stain	.15
0000 sand paper	.10
Alcohol lamp	.10
Stick of transparent, burning-in shellac	.15
Small knife or scalpel	.05

\$1.00

All the above supplies may be obtained from any paint supply store. The scalpel can be shaped from a small

SAVE

How Every Dealer Can Be

table knife and the alcohol "lamp" made by cutting off the small end of a machine oil can nozzle and inserting a wick.

Now for the actual "technique" or procedure required for cabinet refinishing.

Many bruises and scratches come from careless packing or unpacking. If the cabinet has a "press mark," as it is called, first rub down well with the crude oil and benzine mixture. Follow with the pumice stone over the entire surface and finish with a dry rag. To apply the pumice, dip a rag soaked in crude oil in the pumice powder.

Surface scratches should receive the same kind of treatment but deep marks must first be filled. For the latter, light the alcohol lamp, soften the shellac stick in its flame and get a piece of this transparent wax on the

HEAT *the knife over an alcohol flame, then gather on it a bit of shellac*



THEN *fill the indentation until surface comes slightly above the woodwork*



SAND *with a fine grade of sandpaper*



FINISH *with crude oil, rubbing-in mixture*

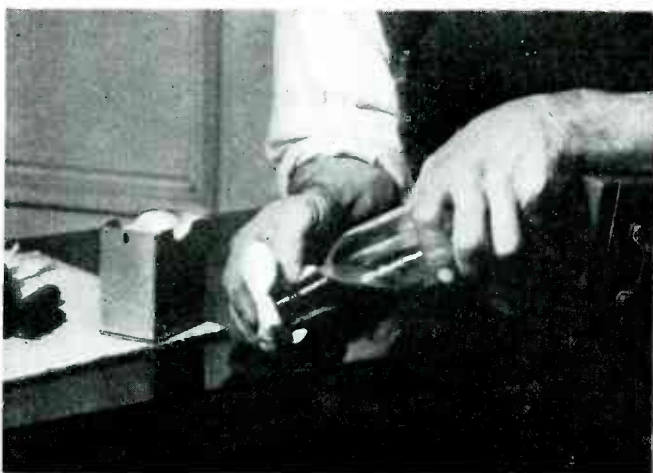

A HUNDRED

His Own Furniture Refinisher

side of the rubbing-in knife. After the indentation has been filled, sand the projecting rough surface flush with the wood. The job is then finished in the same manner as for "press marks" or superficial scratches. Minor dents should be given similar treatment. Deep dents sometimes may be swollen flush by the application of hot water or steam. This process, however, requires care and moderation or the glue under the veneering will become moist and the veneer peel.

Rubbed edges are a common occurrence. They give the cabinet a shopworn look and should be attended to at once. Generally an alcohol rub, applied with a piece of felt, along these edges will suffice. This liquid should be colored with walnut, oak or mahogany stain according to the finish of the set. Bottles of these various stains should be kept on hand.



POLISH *with dry rag over entire surface*

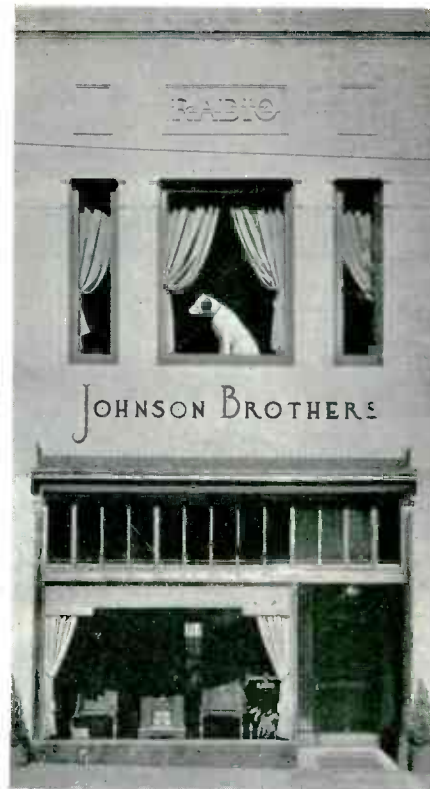

De Luxe

From front facade to rear demonstration room, this beautiful store of the Johnson brothers, Baltimore, Md., approaches the ultimate as a proper setting in which to display home entertainment devices

EXTERNAL APPEARANCE

Individualistic—Has attention value and invites confidence



DEMONSTRATION ROOM

Of correct proportions and proper acoustical qualities—Away from street and store distractions

MAIN FLOOR

Roomy and home-like—Has "atmosphere" suited to the product



The
**JOHNSON
BOYS**

*William
and
Elmer*



Lind Proves THEY'RE DIFFERENT

THE midget complex doesn't worry S. E. Lind a bit. Why? Because instead of side-stepping the issue, he faces it squarely. The advertisement here reproduced tells the story. He frankly features midgets for what they are—devices of limited capacity, at a low performance price. Thus he paves the way, in the public mind, for the ultimate purchase of a *real* radio receiver.

Let's examine closer into the psychology of the advertising and sales tactics of Lind's three radio stores, Detroit, Michigan.

Mr. Lind drives home the basic thought that a great gap lies between the low-priced set and the medium priced, or the de luxe set at \$150. He gets this over in five ways:

1. The use of the phrases: "Midget Reception" and "Quality Reception."
2. He prices the mantel model 'way down to further emphasize this point, and also warns the reader to "Pay no more for any midget set." The prospect thinks, "If the best midget costs only \$17.95 to make and sell, of course there must be a big difference in its performance and that of the other lines he handles."
3. Note the words in the box opposite the names of the standard brands: "For tone clarity, distance, service, real value."
4. If the customer insists on buying a midget, Lind offers full trade-in allowance on the little fellow if it is turned in for a quality receiver within 12 months from date of sale—thus again registering the store's confidence in the superiority of the better consoles.
5. The small sets always occupy a subordinate position in all window and store trims.

"Radio dealers must push the quality merchandise for many reasons," states Mr. Lind, "but especially because 35 per cent of new customers come from the recommendations of old ones. How many of these would we get if our clientele all bought midgets?"

If YOU WANT "MIDGET" RECEPTION



PAY NO MORE
For Any Midget Set

We feel certain that this miniature Radio Set is the equal of any set of this type on the market. New screen-grid Radio. Famous Utah speaker. Only 13 inches high! And if you're buying a "midget" set DON'T PAY MORE THAN THIS, because you can't get finer reception from any midget.

Lind's
Bring You the
Greatest Values
in Midget Radios
You've Ever Seen!

\$17.95
LESS TUBES

Complete With Screen-Grid
Tubes, \$27.85
The Tubes All Carry 6 Months'
Guarantee

FULL TRADE-IN ALLOWANCE
This set can be traded in on a nationally known set for full purchase price within 12 months.

If YOU WANT QUALITY RECEPTION

We Offer a Choice of the World's
Most Celebrated

Radios---



BOSCH
GREBE
VICTOR
PHILCO
ZENITH
KENNEDY
ATWATER
KENT

MAJESTIC
WESTING-
HOUSE
GENERAL
ELECTRIC
STROMBERG-
CARLSON
SPARTON

FOR
TONE CLARITY
DISTANCE
SERVICE
REAL VALUE

LIBERAL
TERMS

No Carrying Charge.
No interest on the
LIND PLAN.

Lind's
Radio Stores

9660 GD. RIVER 6325 FENKELL 7747 W. VERNOR HIGHWAY
Open Evenings

"We have built our reputation on the sale of high-class merchandise," Mr. Lind continues, "and we expect to maintain it in the same manner. We can do this in no more efficient way than to subordinate, in our sales program, midget sets to the real article, and, by force of comparison, making the small set sell the larger one."

The rapid growth and sustained sales volume of Lind's Radio Stores certainly indicates the sound merit of these policies.

15 MINUTES PER HOUR... *This* Ballyhoo

Other Comment

Broadcasting Blah— from Three Angles

THAT the average broadcast program carries altogether too high a percentage of station and sponsor "lineage" and that these impositions on the time and patience of the listener are restricting the wider use of radio receivers, the size of radio audiences and the demand for new sets is generally admitted.

Factual evidence supporting point one has been collected by a special representative of *Radio Retailing*, located in Dubuque, Iowa. Below are the findings of this trained dial twister:

That the broadcasters themselves are keenly, and sympathetically, aware of this situation is deductible from the following statement recently issued by John W. Elwood, vice-president of the National Broadcasting Company:

"Listener reaction is so quick in making itself known," declares Mr. Elwood, "that the evils of broadcasting are 'hurled into the very teeth' of those who permit them to be committed. Program weaknesses are so easily detected, and so promptly reported as to be almost self-corrective. Our sins are visited not upon the third and fourth

generation but today upon those committing them."

Mr. Elwood does not enlarge upon the dependent relationship of the broadcaster to the advertiser, whose money makes possible most of today's programs, or upon the possibilities of reducing the time consumed by silken-voiced announcers. However, in a "Listener's Decalogue," formulated after reading many fan complaints, he recommends (we trust to his clients and employees as well) that the feelings of the set owner should be given serious consideration.

HERE, then, is the program picture as it exists today: The average broadcast schedule requires that the listener must sit through 15 minutes of sandwiched-in extraneous announcement declamations for every 45 minutes of radio enjoyment. Station executives admit that this situation is unhealthy and not in the best interests of either the set owner, the broadcaster or the advertiser. Despite these facts station owners, apparently, are unable or unwilling to cure this evil.

What is the answer? Simply this: Either the broadcasters soon must put their house in order or they will be faced with decreasing revenues, unenthusiastic and diminishing audiences and possible government intervention.

TEN TYPICAL CHAIN PROGRAMS			
Station Announcements	Advertising Messages	Entertainment	Total Time
11 minutes 6%	29 minutes 16%	140 minutes 78%	3 hours 100%
FIVE SMALL LOCAL STATIONS			
4½ minutes 3%	55½ minutes 40%	75 minutes 57%	2¼ hours 100%
FOUR AFTERNOON SUSTAINING PROGRAMS (Medium size stations)			
4 minutes 5.4%	2 minutes 2.6%	69 minutes 92%	75 minutes 100%
EIGHT EVENING PROGRAMS PICKED AT RANDOM (Local and chain)			
12½ minutes 7%	32½ minutes 18%	135 minutes 75%	3 hours 100%
TOTALS			
32 minutes 5.6%	119 minutes 20.9%	419 minutes 73.5%	570 minutes 100%

Ratio is too HIGH

by the Editors

A Radio Tax on Workers and Farmers

EVERYBODY in Washington is talking about the coming taxation program necessary to offset Uncle Sam's rapidly mounting deficit.

Taxes will be clapped onto many things, and it is not likely that radio will escape. Such a tax is recognized by the legislators as being "unpopular" and hence one of the last to be passed. But the fact that Mr. Mellon's proposal is for a "sales" levy, applicable only to new-set sales, and collectible not from the public but through the trade, makes such a radio tax less formidable to the politically-minded legislator, than a general tax to be paid by the public.

If 3,000,000 radio sets are sold in 1932, at an average price of \$70 each, the total to be raised from such a tax will be only \$10,000,000. Recent surveys show that radio sales during 1931 were chiefly low-priced units to the working classes to whom radio is the only form of entertainment and education. And the low saturation of radio sets among our 6,000,000 farms, shows that future sales must supply this rural market.

Hence it is apparent that any proposed tax on 1932 radio-set sales will be borne mostly by the laboring man and the farmer. This placing of the burden should be kept in mind by those who advocate a tax on radio.

Ten Lands Linked

THE very magnitude and almost miraculous character of NBC's international broadcast, Sunday, Dec. 13, in honor of the 30th anniversary of Marconi's first trans-Atlantic message, unfortunately emphasizes again a serious weakness in the handling of publicity on these feature presentations.

For two and a half hours the voices of celebrities and music from all over the world were clearly heard in millions of American homes. Ten lands were linked by air and wire for this stupendous event. Truly this was one of radio's super-events. Yet, due either to lack of time, perception or fa-

cilities, any advance publicity which may have been released was, from the radio dealer's utility standpoint, entirely negligible.

The future will witness program events more impressive than that of last month. Let us hope that their advance advertising will be more in keeping with the importance of these events.

While the Service Man Is Inside

SHREWD merchandisers long ago learned that it is the small items which pull in the dollar volume. Articles priced at a dollar or two find ready purchasers out of "house-keeping money,"—whereas any larger transactions must be the subject of a family conference.

Putting "dollar pullers" in the hands of their service men, some radio dealers find this a ready means of meeting the slump and making servicing pay. Electric lanterns, clocks, toasters, neon lamps, and other handy items, have a way of selling themselves, if presented at appropriate times when the service man is inside the customer's house as an expert with an attentive audience.

Whose Fault Is It?

LIGONIER lies in the heart of the Illinois wheat and corn belt. A recent survey of this town by the managing editor of *Radio Retailing* revealed that not one dealer had for sale a battery receiver. The most active radio merchant explained that the demand was so slight for battery sets that it did not pay to stock them. Granted that this dealer was correct in his statement—which hardly seems possible—does it follow that a town of this size should be so completely unprovided with a product which must have a potential market of not less than 400 prospects within a 20-mile radius of the public pump?

And how can the manufacturer expect to move battery sets if he does not set up some sales plan for meeting just such a condition as exists in Ligonier, and doubtless in many other towns and villages of the same character throughout the country?

SERVICE SHORTCUTS



Holding Circular Parts

By F. W. Seaton

An ordinary vise may be equipped with pegs, as shown in the accompanying drawing, to enable round and circular parts such as dials, coils, speaker units; etc., that ordinarily slip out of the flat jaws to be securely held. Drill three holes in the side of the vise jaws as shown and insert pegs, properly milled into these. The work

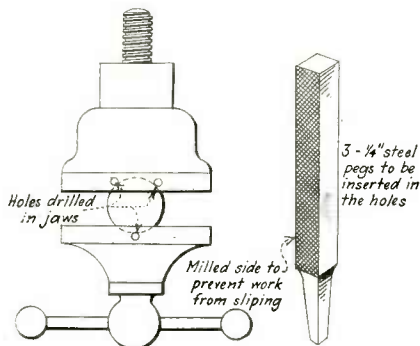

may then be held in the position shown by the dotted circle.

The pegs should fit wedge-tight, so that they may be held firmly in place. When working on other articles the pegs may be removed and thus taken out of the way.

More About 32 Volt Sets

By E. T. Johnson

In a recent issue of *Radio Retailing* a contributor showed how to operate 5-volt battery sets from 32-volt farm lighting systems. The method shown was o.k. where the filament voltage is fixed but many sets control volume by reducing filament voltage on the r.f. tubes. This increases the voltage on the remaining tubes to the extent that their life is materially shortened.

The proper way to hook up a set of this type is to connect an incandescent lamp which will pass the correct amount of current to the r.f. tubes in the filament lead to these tubes and another lamp in the

audio amplifier filament lead, checking up carefully on the voltage supplied to each group when this has been done. An Atwater Kent model No. 35, for example, requires a 25-watt, 32-volt lamp in the r.f. filament lead and another one of the same wattage in the audio filament lead.

Adding More Speakers

By Fred Rippel

As many as thirty magnetic speakers may be connected to a receiver by applying the scheme shown herewith. Connections for an additional dynamic are also shown. The two 2 mfd. blocking condensers are to prevent the direct plate current from flowing through the speakers while at the same time allowing signal voltages to pass to them freely. As these speakers are connected in parallel the maximum volume from them will be the same. Individual volume control is provided through the inclusion of 100,000 ohm potentiometers.

Don't run the common lead from the output of the receiver in metal covered wire as the capacity effect would decrease the volume. Good rubber covered wire will suffice. There is no fire hazard if the condensers will withstand 400 volts when

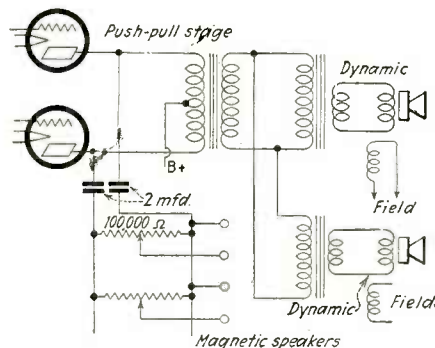

used with 245 tube amplifiers. In the dynamic speakers, a separate field excitation for each additional speaker is required. When you wish to add speakers to a receiver which does not use push-pull output one blocking condenser is sufficient.

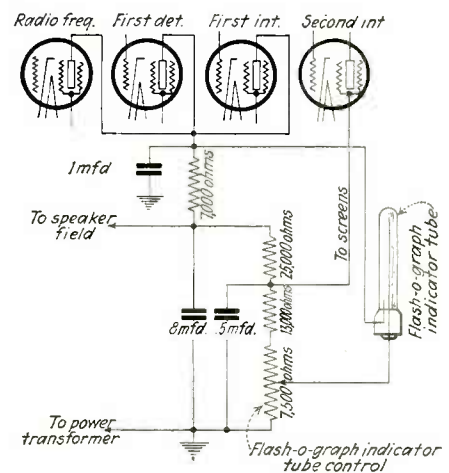

The "Flashograph" Circuit

This circuit shows the position of the resonance indicating device in Fada models. When a large signal voltage is impressed on the first r.f. grid, the bias voltage rises reducing the plate current and as a consequence the IR drop across the 7,000 ohm resistor becomes less. The voltage applied to the special neon lamp consequently approaches the voltage across electrolytic condenser 3-1301 MS. The slider of the potentiometer 3-1324 MS allows the voltage applied to the neon tube to be properly adjusted

Dial Light Repairs

By Lloyd L. Morgan

I have experienced a great deal of trouble with pilot lights in the late all-electric receivers. They apparently burn out in a short time but I have found that only about one in ten is really "shot." Most of them develop bad contacts between the filament and the base, which causes the circuit to open after they have been in use for a short time.

By turning the set on and then thumping the pilot lamp several times with the finger it will often light up again and burn indefinitely. It has even paid me to gather up all the old pilots around the shop and treat them in this manner since I discovered the kink.

Low Volume in Supers

By Stanley C. Newhard

In a super which is not performing with satisfactory volume I found that the trouble was in the plate circuit resistor of the oscillator tube. By changing to a lower resistance value good volume was again obtained. A new tube sometimes restores volume under such conditions but the restoration is only temporary.

Most supers employ such a plate circuit resistor.

Magnet Wire Holder

By M. A. Porter

Most service shops keep various sizes of magnet wire on spools. These may be kept in an orderly and convenient holder where they take up a minimum of space.

Get a strip of 1 x 2 in. board of the desired length and bore $\frac{1}{2}$ in. holes about two in. apart for spools along the center of its length. Insert 4 in. lengths of $\frac{1}{2}$ in. doweling in these holes. Finishing nails can be driven in from the side of the board through the dowels to hold them firmly in place.

Drill a $\frac{1}{2}$ in. hole in each end of the 1 x 2 in. board about two in. deep and in the exact center. Insert lengths of doweling

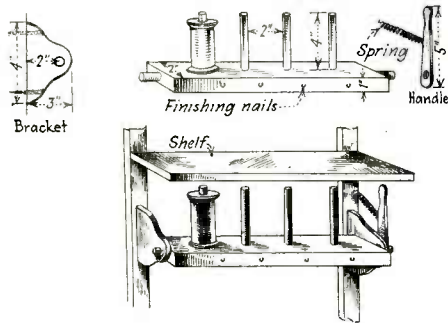

in these holes to serve as a pivot. Now cut two brackets similar to the one shown on this page for the ends, drilling a $\frac{1}{2}$ in. hole in each for the pivots. Make a handle about 5 in. long with a $\frac{1}{2}$ in. hole in the end.

Assemble the holder by placing the two

Another
"Brother
-in-Arms"

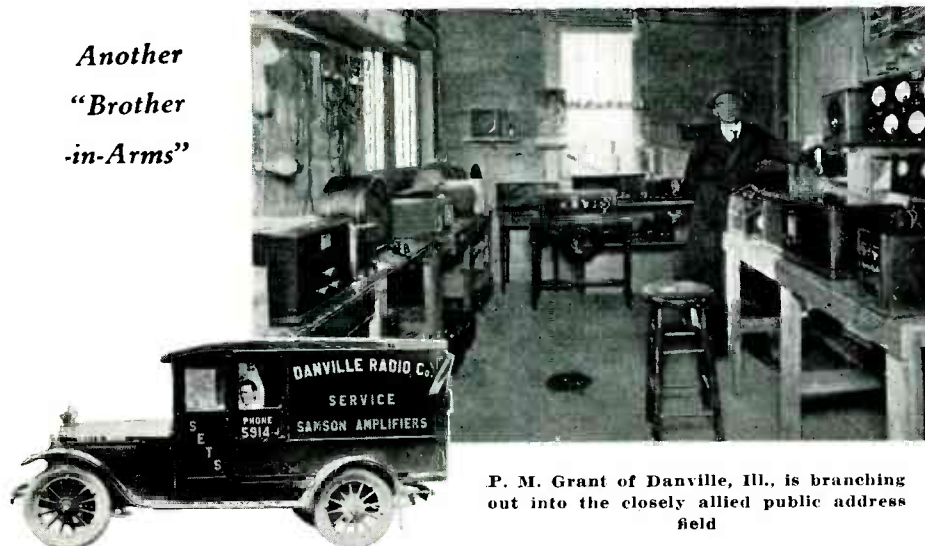

P. M. Grant of Danville, Ill., is branching out into the closely allied public address field

end brackets on the wall the correct distance apart, with one pivot shaft projecting through far enough to accommodate the handle. Slip the handle over the end of the dowel pivot and secure it with a finishing nail. Fasten the spring to the wall. Place magnet wire spools on the dowels.

Now, when a spool of wire is desired, pull down the handle and remove it. The holder will snap back in place of its own accord.

Continuity Tester

By Wilbur T. Golson

In testing for continuity I use a 0-6 d.c. voltmeter originally manufactured by Hoyt for Radiola 28 superhets. Its type number is 77. This is used in series with a pair of test prods, a 45 volt B-battery and a resistor variable from 0 to 250,000 ohms.

By turning the resistor knob the meter can be set to any desired voltage for testing. With the resistance turned as low as possible the meter hand will only be slightly off scale. With the indicator set to read exactly 6 volts a resistor of 12,500 ohms will give a reading of one volt. It is thus an easy matter to convert this instrument into a combined continuity and ohmmeter device reading ohms directly up to 12,500.

The ohmmeter scale is particularly valuable in testing dynamic speaker fields of high resistance and in testing carbon type volume controls.

Handy Parts Trays

By Ivo V. Pennington

Shallow cake tins, about 7 by 10 inches by 1 inch deep, make excellent trays for a replacement parts stock. Two boards about 1 ft. wide are nailed vertically against a wall, with one edge facing out, and cleats nailed on their inner surfaces to form ledges into which the cake tins may slide.

Such a unit has the advantage that a serviceman can look into the tins and see what parts they contain without removing them from the shelving. This is not possible where the parts are kept in bottles or in cabinets.

PILOT LIGHTS

SPARTON 410. A broken-down Mershon filter condenser sometimes causes the $1\frac{1}{2}$ amp. fuse to blow. When this happens, check the circuit to be sure the Mershon is at fault, then insert a 3 amp. fuse in the socket and turn on the current. This will pass enough current to permit the self-healing electrolytic to re-form. When this process is complete remove the 3 amp. fuse and replace it with the original $1\frac{1}{2}$ amp. size.

GE-T41. Poor contact at the gang condenser rotors frequently causes reception to cut out. Trouble may develop at the small contact springs on three of the units or at the bearing of the fourth and sandpapering is only a temporary cure. To permanently stop trouble solder a piece of flexible wire to the rotor shaft near the dial end, using a heavy iron, and catch the other end of the wire under a bolt head on the condenser gang frame.

RADIOLA 28. Selectivity and sensitivity may be greatly improved by substituting an antenna and ground for the loop. The necessary coupler is constructed by placing two 26 dcc wire windings on a tube $2\frac{1}{2}$ in. in diameter and $3\frac{1}{2}$ in. long. The aerial coil, or primary, should be 25 turns, close wound. The secondary should contain 50 turns tapped at the center, or 25th turn. Space the windings $\frac{1}{2}$ in. apart. Mount two binding posts, for antenna and ground on the edge of the tube. Mount the coupler on the inside of the cabinet and carry flexible wires from the secondary to the loop socket. The two outside connections of the coupler go to the two outside terminals of the loop socket and the center tap connects to the center terminal of the loop socket.

APEX, GLORITONE, MONTGOMERY WARD. Excessive oscillation is usually due to a dirty contact in the spring that fits between the rotor and frame of the gang condenser. Lift the spring out with a screwdriver, sandpaper, increase tension, and replace.

AK 37. To repair condenser blocks cut off bottom of can close to edge with a sharp $\frac{1}{2}$ in. chisel and a hammer. Cut off the end flap under condenser end. Remove compound and paper. Unsolder ground lead from the sections. Locate and isolate defective section. Now drive tinned strip $\frac{1}{2} \times 1\frac{1}{2} \times \frac{1}{2}$ in. with 10 in. insulated lead attached down through the defective section. This lead will be soldered to exterior replacement section. Run lead from the other side to ground. Insulate the bottom of defective section from possible grounds. This is important as the bottom and lead are now at high potential. Replacement 2 mfd. can be stowed topside the power transformer can.

CROSLY SHOWBOX. If signals fade, or if the set oscillates when the dial is touched, remove the little washer between the condenser housing and the pinion gear and sandpaper where it makes contact, bending it so that it makes tighter connection, and replace.

NFRA Annual Convention

January, 1932

Swift Surveys of

FEDERATED SHIFTS TIME AND PLACE

*To be Held in Conjunction with Radio-Electrical Show,
Which It Now Endorses*

Originally scheduled for Philadelphia, Feb. 16-17, the annual combined convention of the National Federation of Radio Associations and the Radio Wholesalers Association has been set ahead to this month, and the place of meeting changed from Philadelphia to Chicago.

In a special telegram to this magazine, dated Dec. 24, the revised plans, and reasons therefor, are stated by H. G. Erstrom, executive vice-president of Federated, as follows:

"Board of directors of both associations announce annual convention, NFRA and RWA, concurrent with, and a part of, the Chicago Radio-Electrical Trade and Public Show—to be held in Chicago the week of January 18-24. Both associations endorse show and the incorporation of this activity as part of their merchandising program.

"Advisory committee believes radio jobber and dealer must broaden scope of their activities by handling allied lines such as electrical appliances.

"Thousands of tradesmen will attend combined show, radio rally, forums and convention meetings in Chicago in January. We invite all members of the distributing fraternity irrespective of affiliation with our association or any other. We wish to discuss with them matters of common interest upon which our associations need the opinions of all progressive tradesmen."

It further was pointed out in this special dispatch that the Chicago radio show has been a feature of mid-western radio affairs for ten successful years—and that the amount of space now under contract assures another representative exposition.

The convention meetings, to be held at the Congress Hotel, will be as follows: Monday, Jan. 18, registration; Tuesday, National Radio Rally; Wednesday, Closed membership meeting; Wednesday evening, annual banquet.

RMA Opposes Radio Tax

Forces of the Radio Manufacturers Association and other industry branches are organizing to oppose the special sales tax of five per cent on radios, phonographs and accessories proposed to Congress.

Although not opposed to a small general sales tax, RMA will fight the special tax in Washington. The National Association of Broadcasters already has gone on record against it and the support of the Radio Wholesalers Association and the National Federation of Radio Associations is assured.

Anticipating this proposal, the RMA Board of Directors weeks ago prepared to battle against it. President Coit authorized the association's legislative committee to wage vigorous opposition to a special sales

tax on radios and accessories. In Washington RMA has its special legislative counsel, Frank D. Scott, in constant touch with congressional developments and in immediate charge of the association's opposition.

On December 11 the RMA receiving set committee, comprising major radio manufacturers, met at the Hotel Commodore, New York, and launched the industry's opposition, "to the special and discriminatory sales tax, proposed only against radio and one or two other industries."

1931—A Year of Outstanding Broadcasts on NBC Hook-ups

Thirty-three thousand broadcasts, involving more than one-quarter million participants in a score of nations, comprised the 1931 program year of the National Broadcasting Company.

The NBC year revealed the world in review with stirring events and dynamic personalities on the air for the first time. First international addresses by Premier Mussolini and Pope Pius XI inaugurated the radio cycle. World flights, political and sport spectacles followed. A globe-girdling tribute to Marconi, the Oxford-Harvard debate and the radio premiere of Metropolitan Opera climaxed broadcasting of 1931.

Tabulation of programs transmitted on the two NBC trans-continental networks reveal that 33,750 were carried during the year just closed. Persons who participated in these broadcasts totaled 317,750.

Broadcasting developments by NBC brought the addition of \$1,000,000 in talent to daytime programs, establishment of television studios and laboratories atop the Empire State Building and the addition of a second Pacific Coast network.

International hook-ups numbered more than 125, originating in 20 foreign countries, including those which participated in the radio roll call honoring Guglielmo Marconi on the 30th anniversary of the day he first spanned the Atlantic by wireless. England led the list with fifty-five exchanges.

Forty major sporting events were described. They included the great racing derbies of England and America and ranged in character from championship baseball, football, boxing and golf to the opening of the Culbertson-Lenz bridge table battle.

Fred Williams Joins Mallory As General Manager



Fred D. Williams has been elected vice-president and general manager of P. R. Mallory & Company of New York and Indianapolis. Mr. Williams has severed his connection with the National Carbon Company, of which organiza-

tion he has been manager of Eveready Raytheon Tube Division and, prior to that, vice-president of the Raytheon Manufacturing Company, which was taken over by National Carbon.

In his new work, Mr. Williams will be concerned with P. R. Mallory & Company, and its subsidiaries, Elkon, Inc., Knapp Electric Company, and Yaxley Manufacturing Company.

The Mallory company is a large supplier of contacts for ignition and relay applications, besides being a pioneer in dry electrolytic condensers which it markets under the trade name Elkon.

The Knapp Electric Company manufactures electric specialties. The Yaxley Manufacturing Company of Chicago, a recent acquisition, has been active for a quarter of a century in the making of electrical and radio parts.

Edwin R. Weeks Makes 15-Minute Promotional Record—Available for Dealers

Edwin R. Weeks, president of the National Association of Music Merchants, and an artist of note in his own right, recently completed a 15-minute phonograph record recording for sales promotion purposes by music and radio dealers. This transcription consists of a short duet with Mrs. Weeks, a solo and several humorous odes and verses by Mr. Weeks.

The spoken portion stresses the advantages of music in the home and constitutes valuable and timely propaganda for music merchants.

Dealers who can arrange to place this record on the air over their local stations, or to play it in their store, will find it of exceptional worth. The transcription, in its entirety, consists of two double-faced records, and is available at \$5 for the set. Orders should be sent to the Executive Office of the National Association of Music Merchants, 45 West 45th St., New York City.

January 18-20 at Chicago

the News Bombardments

New York, N. Y.

CHICAGO SHOW OPENS JAN. 18

Exhibit and demonstration rooms will be maintained at the Congress Hotel by manufacturers during the forthcoming Chicago Radio Electrical Show, Jan. 18-24, it has been announced by G. Clayton Irwin, Jr., general manager.

The Institute of Radio Service Men will hold its January convention concurrently with the show, and, like the National Broadcasting Company and Columbia Broadcasting System, will make the Congress Hotel its headquarters.

The public will be received at the Coliseum where, for the past nine years, the annual show has been held.

It was purposely to insure the "secondary selling season" getting under way without lost motion that the Chicago show was postponed from October. The majority of manufacturers realized that without such a vehicle as a national trade and public show to generate country-wide interest, it would be impossible to impress the idea forcefully upon the public, Mr. Irwin claims.

J. M. Spangler Heads Eveready Raytheon Tube Div.



National Carbon Company, Inc., has announced the appointment of J. M. Spangler as manager of its Eveready Raytheon Tube Division. Mr. Spangler succeeds Fred D. Williams, who recently resigned to become an officer of P. R.

Mallory and Co., New York City. Mr. Spangler's appointment follows sixteen years' connection with the company, during which time he has held many important positions.

Prior to taking over his new duties in the tube division he was manager of the eastern division, a position he held several years. His services with National Carbon Company began in 1915 as railroad sales engineer. In 1918 he organized the railroad department in which he served as manager until 1923, when he was appointed manager of the company's central division, followed by promotion to Eastern manager.

Mr. Spangler is a graduate of the electrical engineering department of Pennsylvania State College.



Lawrence Tibbett to Broadcast

Harvey S. Firestone, Jr., vice-president of The Firestone Tire Company and Lawrence Tibbett (right) signing contract by which the famous singer, distinguished as a great star in grand opera, talking pictures and the concert stage, becomes a regular feature of the Voice of Firestone radio program.

The Tibbett series of radio performances starts January 4 and will continue through the winter season, at 8:30 in the evening and again at 11:30, eastern standard time, over a giant hookup of the Red Network and affiliated stations covering the entire United States and Canada and by short wave to the entire world

Vertical Recording Demonstrated

An advance in recording sound on a phonograph disk was demonstrated last month at the Engineers' Building, New York City, before a joint meeting of the Institute of Radio Engineers and the Society of Motion Picture Engineers by Halsey Frederick, of the Bell Telephone Laboratories.

Using a new type of disk phonograph record, on which the undulations are cut into the record's spiral groove in a vertical position, a high-power amplifier and a bank of loudspeakers, Mr. Frederick reproduced organ, vocal and orchestra music, which his auditors declared could scarcely be distinguished from the original sounds, either in quality or in the volume of the sound produced.

Mr. Frederick explained how the vertical method of recording sound on a disk differs from the "standard" way of making records, which is known technically as the "lateral" method of recording. Ordinary records are made by causing the recording needle to waver back and forth or sidewise in the spiral groove or needle track. In the new method, the needle moves up and down over a series of short and long humps that correspond to the frequency or tone of the sound recorded.

Tones corresponding to frequencies up to 10,000 cycles per second are easily produced, Mr. Frederick said.

COLUMBIA VOTES TO MERGE WITH GRIGSBY-GRUNOW

The day before Christmas the voting trustees of the Columbia Phonograph Company, Inc., approved the sale of that concern's capital stock to the Grigsby-Grunow Company, of Chicago. This action signals one of the largest, and what should prove to be one of the most interesting, consolidations yet witnessed in the radio industry. Columbia formerly was owned by the Columbia Graphophone Co., Ltd., of England. American capital gradually gained control and last summer, when a voting trust was set up for the American firm, Radio Corporation of America was reported as holding about 30 per cent of the capital stock of the English parent company.

In exchange for each share of their stock, Columbia Phonograph stockholders will receive 4.4 shares of Grigsby-Grunow stock. It was further stated that the management of Columbia plans to declare a capital dividend of \$10 a share. This latter concern enjoys a substantial export business particularly in South America. Its plants are located in Bridgeport, Conn., and Los Angeles, California.

In a pre-Christmas statement, B. J. Grigsby, president of "Majestic," said: "This consolidation will be of material benefit to both companies and give a substantial increase in production to our company."

Brunswick Disc Sales Taken Over By New Company

The Consolidated Film Industries, Inc., New York, has organized the Brunswick Record Corp., to take over the manufacture and sale of Brunswick, Melotone and Vocalion records for the U. S., Canada and certain foreign countries.

Practically the entire sales and laboratory personnel and management of the Brunswick Radio Corp. has been turned over to the new company.

Headquarters will be maintained at 1776 Broadway, New York City, with branch offices in Chicago, Cleveland, Dallas, Kansas City, Los Angeles, Minneapolis, New Orleans and San Francisco, at the same addresses formerly occupied by the Brunswick Radio Corp.

J. C. Van Horn, of Philadelphia, has been elected a vice-president of R.C.A. Institutes, Inc. He will be in charge of the four resident schools at New York, Chicago, Philadelphia and Boston.

"OPEN PATENT POOL" POSSIBLE

Government's RCA Suit to be Adjudicated

Personal inquiry at the Department of Justice, Washington, by an editor of this paper indicates that with the close of December steps will be concluded for setting up an open patent pool in radio. This pool to be administered by three trustees, one representing the Department, one the Radio Corporation of America, and the third to be selected by these two.

Meanwhile the original suit against the Radio Corporation filed by the government will be prosecuted on greatly narrowed issues. This suit will be carried before the courts to the point of getting adjudication on several moot questions, but with the matter of the patent pool definitely removed from the case. Ratification of the plan of procedure by the interested corporation parties, was the only remaining formality, it appeared just before the Christmas holidays.

Negotiations had come a rocky path since the conferences last summer, and there were several periods during the conferences this fall when all possibility of amicable settlement seemed to have been given up by both sides. Only in November were negotiations reestablished, and a drastic dissolution suit prevented through the consent to set up a patent pool.

Complaint has been filed by some of the independents that the proposed pool may be "too wide open" for the good of the established independent radio industry, permitting and encouraging radio newcomers or any one to take out licenses. This prospect of twenty or thirty additional radio manufacturers is prevented, it is explained, by the provision of wide discretionary powers given the trustees who can use their own judgment as to granting additional licenses.

Later, it was reported that possible objections to these plans might lie in objections raised by other interested parties.

The case for the Department of Justice has been in charge of Judge Warren Olney of California. Washington opinion credits Oswald Schuette, of the Radio Protective Association, with chief honors for having kept persistently and single-handed at the task of smoking out evidence leading to the establishment of an open patent pool.

I. R. C. Reduces Prices

Increased production has enabled the International Resistance Co., Philadelphia, to reduce prices approximately 40% on all types of metallized resistors. The same discount from list price still applies.

"Radio Retailing" Seven Years Old

Seven years ago, in response to the need for a genuine business paper of the radio industry, "Radio Retailing" was established. Under the editorship of its founder, O. H. Caldwell, this magazine has consistently pointed the way to sound merchandising practices and kept its industry informed as to all vital happenings and trends.

Maurice Clements, William C. Alley and Ray V. Sutcliffe have been its successive managing editors—the latter having occupied this post since May, 1929.



Trouting Near Lake Tahoe

George H. Curtiss, secretary-treasurer, Pacific Radio Trade Assn., San Francisco, on a trout stream in the Sierra, near Lake Tahoe.

Radio Exports Increase 50%

Continuing in September the marked upward trend of previous months, exports of radio receiving sets from the United States registered a total increase of over 50 per cent for the first nine months of the current year as compared with the corresponding period of 1930, according to the Commerce Department's Electrical Division.

Adds "Television" to Name

Believing that the name "Trav-Ler Radio & Television Corp." will better describe its aims and activities, the former Trav-Ler Mfg. Corp. has changed its name. This company makes television equipment, including kits and combination radio and television receivers.

Union Film Labs. Formed

Continuing with his plan to place 16 M/M movies on a big business basis, Rudolf Mayer, president of International 16 M/M Pictures, Inc., and brother of Louis B. Mayer of Metro-Goldwyn-Mayer, has acquired the U. S. Laboratories at Hudson Heights, N. J. This is the second purchase made by Mr. Mayer within ten days, and it is his intention to merge both into a huge organization which will have a weekly capacity of

more than 4,000,000 ft. of 16 M/M film. The new organization will be known as the Union Film Laboratories.

Gibson District Manager Appointments

GIBSON ELECTRIC REFRIGERATOR CORP., Greenville, Mich., has appointed the following district managers:

P. W. Peck, Atlanta, southern district; J. F. Krenkel, Los Angeles, west coast district; Geo. M. Farrin, eastern district; and R. G. Seldomridge, Chicago, middle west district manager.

Lee Blair, President P.R.T.A.

Lee S. Blair, Blair Hardware Co., and a director of the Pacific Radio Trade Association, has been elected president of the San Francisco Radio Retailers' Association. Harry Zemansky, of Zemansky & Fass, was chosen vice-president.

Other directors elected were: R. J. Byington, Byington Electric Co.; Louis Levy, Levy Electric Co.; E. Roy Nash, Eastern Outfitting Co.; Jerry Hirek, and A. E. West, Christophe's.

NEW JOBS, NEW JOBBERS

R. C. HAGER, vice-president and general manager of the Arnold Wholesale Corp., has been elected second vice-president of The Tracy-Wells Co., in charge of merchandising for both companies. The Arnold Wholesale Corp., over which Mr. Hager will retain executive supervision, is the Cleveland branch of Tracy-Wells.

H. R. WILLIAMS, formerly connected with the Brunswick Radio Corp. as head of the technical division of the New York branch, has organized the United Radio Service Company, taking over the replacement parts and service department of the Brunswick Radio Distributing Co. The New York, New England and New Jersey territory is covered.

A. BERT AVERS, whose career in radio dates back to the early days of the industry, has been appointed special factory representative for Pacent.

J. E. BROYLES has been promoted to the post of general manager of Capehart. He was recently in charge of credit and collections, and has been with Capehart since the first year of its operation.

W. H. HUTTER has stepped up to the important job of chief engineer of Capehart.

Holbrook electrical refrigerators and Jackson Bell radios are being distributed in Arizona by the REDEWILL MUSIC Co., Phoenix. Cass Redewill is in charge of the new radio and refrigeration departments.

LEO J. MEYBERG Co., of San Francisco and Los Angeles, is handling Norge refrigerators in those two cities. George R. Pizaro, factory representative for Norge on the Pacific Coast, has his headquarters with Meyberg at San Francisco.

NORGE CORP. recently acquired the Alaska Refrigerator Co. of Muskegon, Mich., maker of boxes for several refrigerator manufacturers.

Merchandising

PHONOGRAPH DISCS

TWO FIRMS POINT THE WAY

By

Richard Gilbert

NUMBERLESS metropolitan dealers and not a few from the hinterland have indicated in recent communications that whereas their sales of the so-called popular type of phonograph records are steadily decreasing, sales of album sets and individual records of the classical music variety continue to mount monthly. Having been active in the field of recorded music ever since the advent of electrical registration, from both the merchandising and the publicity angles, this bit of news comes as no surprise but confirms a prophecy made several years ago.

If record dealers have noticed the increasing demand for music of the better quality—something which will not stale tomorrow but continue to whet appetites for more fare of similar lastingness—they may thank the pioneering spirit displayed by such independent dealers as two New York and Philadelphia houses: The Gramophone Shop, Inc. and the H. Royer Smith Company.

These stores have merchandised almost as many records during three years of business, exclusively catering to disc collectors, as all the Red Seal or Celebrity or International Hall of Fame releases sold by other dealers throughout the United States.

The Gramophone Shop's business is built around their own 372 page catalogue *The Encyclopedia of the World's Best Recorded Music* (first edition: 1930; second, 1931) which embraces the serious offerings of every major phonograph company in the world. Due, perhaps, to the lack of alertness by other dealers throughout the country this firm and the Philadelphia company have built up mail order businesses furnishing domestic records as well as imported ones to customers who have difficulty in obtaining local sympathy or service. Furthermore, the New York store succeeds in selling their Encyclopedia for twenty-five cents per copy and prints editions running into five figures.

In Philadelphia, the H. Royer Smith Company, seeing the lack of advertising publicity furnished by the publishing companies, went ahead two years ago and founded their own phonograph monthly review, the fifteen-cents-per-copy *Disques*. Its circulation continues to grow rapidly and its contents advise collectors in unbiased fashion of the merits and demerits of both domestic and foreign publications.

When record merchandising becomes the topic of con-

versation, mention of these two pioneering dealers cannot be withheld. Most pertinent at present is the fact that they, rather than the record makers, deserve the credit for keeping sound reproduction on its feet and for assisting the smaller dealer into a remunerative side line. The success of these firms augurs well for the future and should lead other dealers to look more closely into the album set and standard classical music recordings.

Many dealers, be it noticed, have found *The Encyclopedia of the World's Best Recorded Music* of value to their sales forces and have discovered that *Disques* on sale in their stores promotes phonograph record business. Both companies are glad to cooperate with the interested dealer.

ONE of the greatest mysteries of the record business is the lack of adequate advertising of phonograph records. Should book publishers show the same perfunctory interest in merchandising their wares I doubt if there would be such things as best sellers.

In the phonograph column of *The New York Times*, December 20, 1931, Compton Pakenham writes as follows:

"From our correspondence it seems that it has been only through the medium of this department that several collectors have learned of the growing album libraries . . . which only confirms our opinion that the real trouble with the record business is on the inside. . . . If the various companies really agree with us that the 1931 gramophone is better than the 1921 affair, it is for them to convince the world and, until they have given their product a fair trial, stop berating the dear public for not buying a pig in a poke."

To which I might add similar remonstrances brought about by my experiences as a weekly phonograph review columnist in the *Musical Courier*.

BUT the demand has been demonstrated. If dealers want to push a business which is grounded on as firm a rock as music itself they can do no better than investigate the album set sort of better music. A fair knowledge of the art's history, record catalogues and current releases, and the ability to gauge the music lover's taste are all the requirements necessary. The quality of present day sound reproduction properly demonstrated, will do oceans more than the most erudite sales talk regarding the majesties and beauties of Beethoven's symphonies or Wagner's music dramas. The customer wants to be waited on by intelligent people but, most of all, he wants to know *where, when and what* he can buy of the music he wants.

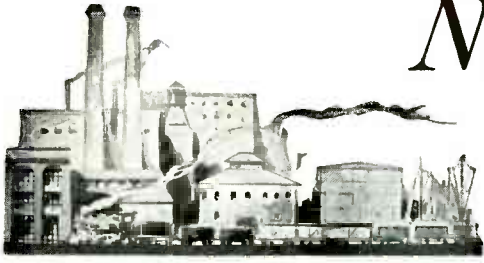

New Products for

All announcements appearing on these pages are published without advertising considerations of any kind whatsoever.



Western Television Receiver

A COMPLETE television set, including "Visionette," the television unit, and a short wave receiver, is being made by the Western Television Corp., 400 W. Madison St., Chicago, Ill.

The Visionette comes in a walnut table cabinet, 18x20x9 in., and the short wave receiver is housed in a matching cabinet, 14x10x9 in. The price complete, including glow lamp for Visionette and tubes for short wave receiver, is \$150. Those who already have a short wave set may purchase the Visionette separately for \$85.

For the home set builder who owns a short wave set, Western Television has designed a kit for experimental work. There are only seven parts to put together, and the set can be completely assembled in a short time. \$59.50. The Visionette cabinet is \$14.—*Radio Retailing*, January, 1932.

All-Electric Motorola Auto-Radio Set

AN ALL-ELECTRIC Motorola auto-radio set eliminating B-batteries has been announced by the Galvin Mfg. Corp., 847 W. Harrison St., Chicago.

It comes in two models—a 7-tube t.r.f. and an 8-tube superheterodyne. These sets have automatic volume control, motor noise is said to be eliminated, and installation is easier than on previous models.—*Radio Retailing*, January, 1932.

Simplex Superhets

AN entirely new line of superheterodyne instruments has been announced by the Simplex Radio Co., Sandusky, Ohio. There are two chassis—a five tube and a seven tube.

In the 5-tube chassis line there is a midget listing at \$32.50, a special model at \$35.50, a lowboy at \$46.50, and a grandfather clock model at \$67.50.

With the 7-tube chassis, there is a midget at \$49.50 and a console at \$59.50.—*Radio Retailing*, January, 1932.

Condensers

EXPERIENCE has shown that absorbed moisture lowers condenser resistance and condenser life so the Tobe Deutsmann Corp., Canton, Mass., has placed on the market a moisture-proof condenser which, it claims, will maintain its original high resistance. They are known as "Surgproof" condensers, and come in two types, service condensers for all types of radio power unit repairs and tubular by-pass condensers for use in receiver chassis. The prices for the former range from 75 cents to \$2 and for the latter from 60 cents to \$1.90.—*Radio Retailing*, January, 1932.

Aerovox Replacement Condenser Blocks

REPLACEMENT units for the Majestic 9-P-6 and 7B-P-6, and Atwater Kent Models 37 and 38 power supply units may now be obtained from the Aerovox Wireless Corp., 70 Washington St., Brooklyn, N. Y.—*Radio Retailing*, January, 1932.

King Automatic Combination

THE latest contribution to the automatic combination field, comes from Huntington, Ind., where a fully automatic record changing mechanism known as the "King" has been developed by the Superior Automatic Phonograph Company. It is silent in operation and the changer plays ten 10-in. records on both sides, continuously and without attention. The records stand on edge in the record magazine, preventing warping or sticking together.

This instrument is furnished in two models—one a coin-operated model for commercial use, with illuminated mechanism in glass panel front, and a domestic model for home. Both offered at a much lower price than former models. The coin operated model is \$395 while the home models range in price from \$375 to \$425.—*Radio Retailing*, January, 1932.



Ansley Portable for A.C. or D.C.

THE new 6-volt heater type tubes (three 336, one 337, a 538 pentode and a 280 rectifier) are used in the universal a.c.-d.c. portable of the Ansley Radio Laboratory, 147 West 23rd St., New York City.

The universal operation is made possible by a combination of a series filament arrangement which is used on either current, and a switching device consisting of a ten contact plug. This is provided with two caps—one for a.c. and one for d.c. All the connections needed to change from one current to the other are brought out to the terminals of this plug and the two caps complete the circuits in the proper way for either current. The speaker is the new 150 Magnavox.

This set is encased in a black or brown leatherette case, measuring 9½x10½x15 in. and weighing 22 lb. The price complete is \$69.50.—*Radio Retailing*, January, 1932.

Police Low-Wave Converter

RADIO Service Maintenance Co., 1460 Huron St., Toledo, Ohio, is manufacturing an article known as the "police low-wave converter" to retail for \$3. It is made for use on either a.c. or d.c., t.r.f. or superheterodyne sets, and is adaptable for either the 227 or 221 type tube. The wavelength is adjustable, and when attached to a radio will tune from 80 to 180 meters, the radio dial doing the tuning. Installation is simple.—*Radio Retailing*, January, 1932.

Mars Model 70

RADIO Sight & Sound Corp., 230 N. Michigan Ave., Chicago, Ill., offers the Mars console model 70, a seven tube superheterodyne incorporating both multi-mu and pentode tubes, to be shipped direct from the factory, complete with tubes, for \$32.50, f.o.b. factory. Cabinet, with speaker mounted, is shipped from Marion, Ind. All that is required is to place the chassis in cabinet, screw in the four screws and plug in the speaker.—*Radio Retailing*, January, 1932.

Dubilier Capacitors

A LINE of molded case mica capacitors, ranging from a few microfarads to .2 microfarads, and for working voltages up to 5,000, is announced by the Dubilier Condenser Corp., 4377 Bronx Blvd., New York City.

Dubilier also has available PL-357-9 meter by-pass capacitor, to provide ample protection to transmitting set meters against the heavy surges caused by induced r.f. currents. It is available in any capacity up to .02 microfarads.

A new line of high-frequency capacitors, Type PL-341-62, is also ready, as well as a series of dry type electrolytic filter condensers. The latter are available in standard capacities and for peak voltages up to 430.—*Radio Retailing*, January, 1932.

Fada D.C. Sets

AN improved superheterodyne circuit using 8 tubes including 2 type F-257 d.c. pentodes in push-pull, is incorporated in the new d.c. set being made by F. A. D. Andrea, Inc., Long Island City, N. Y.

Model 171 is a table set, \$72.50 complete. Model 173 is a lowboy, \$92.50 complete.—*Radio Retailing*, January, 1932.

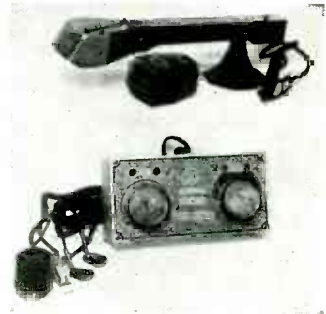

Patent "Recordovox"

A NEW combination recording and reproducing device that works with any receiver or phonograph, and increases the entertainment value of both, is announced by the Patent Electric Co., 91 Seventh Ave., New York City. Known as the "Recordovox," this attachment will convert an old-style phonograph into one which will reproduce records electrically. It also allows for the making of home records of voice, music, etc. Permanent connection to the radio receiver is made without disturbing existing wiring. The retail price, minus microphone, is \$27.50. The microphone sells for \$10.—*Radio Retailing*, January, 1932.

Dealers to SELL

This editorial section is prepared purely as a news service, to keep readers of "Radio Retailing" informed of new products.



Philco Model 112X

TWO radically new features are included in the Philco Model 112-X which will be placed on the market by the Philadelphia Storage Battery Company, Philadelphia, Pa., just as this issue is released.

The first is a heavy, hardwood inclined sounding board, which carries the speaker firmly attached. This new construction eliminates the tone chamber, sends to ear level the high tones ordinarily projected below the range of hearing, and delivers tone in all the brilliance of the full musical register.

The second feature is the echo screen in the back of the cabinet. The incline of the sounding board deflects the reverse delivery of sound to the floor of the cabinet and sound blankets absorb this secondary broadcast so that it cannot re-echo from the back to become confused with the primary broadcast from the front.

Model 112-X carries the 11 tube, superhet chassis, and lists at \$150.—*Radio Retailing*, January, 1932.

New Dubilier Products

A LINE of low-voltage electrolytic condensers is being made by the Dubilier Condenser Corp., New York City. These compact, convenient units are especially suitable for audio by-pass applications and in plate and grid filters of the resistance-capacity type where high capacity and low impedance are essential.

They are obtainable in two forms: namely, a small metal can of rectangular shape which can be mounted between tube sockets; or a cartridge type container similar in size and appearance to carbon resistors and cartridge type paper condensers.

Dubilier is also making two types of molded Bakelite mica capacitors for transmitting and receiving circuit applications. Type 3 covers various capacities from .00004 to .004 mfd., and Type 4 covers from .00004 to .025 mfd.—*Radio Retailing*, January, 1932.

Capeharts With 2-Speed Arrangement

ANNOUNCEMENT comes from the Fort Wayne, Ind., office of the Capehart Corp. that the 400-Series automatic combinations now have a two-speed arrangement for handling the new long-playing and program-transcription records, as well as the standard 10-in. and 12-in. records.

The 10-in. long playing record, as well as the standard 10- and 12-in. records, are handled continuously and automatically. The 12 in. long playing record is placed on the turntable and after the selection on the one face is played, the mechanism turns the record over to play on the other side. A new record must then be put on the turntable.—*Radio Retailing*, January, 1932.



RCA Victor Combination to Play New Records

A LOW-PRICED radio-phonograph combination to play new long-playing records as well as the ordinary records, and incorporating an improved 9-tube superheterodyne receiver, has just been placed on the market by RCA-Victor Company, Camden, N. J.

It will be known as Model RE-18, with a list price of \$147.50 complete. It has ample record storage room in a well beside the turn-table. A sample 10 in. program transcription featuring popular Victor recording artists is packed with each instrument for demonstration purposes.—*Radio Retailing*, January, 1932.

Pilot "All-Wave" Set in Console Cabinet

OWING to the keen interest shown in all-wave sets, the Pilot Radio & Tube Corp., Lawrence, Mass., has made available its Super-Wasp 11-tube superheterodyne all-wave set in a console cabinet of the six-legged type.—*Radio Retailing*, January, 1932.

Conoid R. F. Coils

DUE to the small size of the new Conoid type r.f. coils manufactured by the Premier Electric Co., Grace & Ravenswood Aves., Chicago, Ill., they are meeting with favor among manufacturers of midget sets and auto-radios. The windings are self-supporting and are not wound on a core, which practically eliminates all absorption losses, and greatly reduces high frequency loss resistance. The cans are soft copper, 2 in. in diameter and 1 1/8 in. deep. They are furnished in matched sets.—*Radio Retailing*, January, 1932.

Sorber 2-Volt Battery Sets

A LOWBOY console inclosing a screen-grid battery radio using 2-volt tubes and air-cell battery is made by the Sorber Radio Mfg. Co., 1418 Cherry St., Kansas City, Mo. It is walnut with maple overlay. The speaker used is a Utah electro-magnetic, and the list price of \$93.30 includes all equipment used.

The same chassis can be obtained in a midget cabinet for \$79.15. As the batteries have to be stored inside, it makes this cabinet slightly taller than the average midget but it is of graceful lines and sturdily constructed. The size is 25 1/2 in. high by 14 1/2 in. wide by 9 in. deep.—*Radio Retailing*, January, 1932.

Fada Cordless Electric Iron

TO round out its line so that Fada dealers may operate profitably throughout the entire year, F. A. D. Andrea, Inc., Long Island City, N. Y., has brought out a new cordless, automatic electric iron.

It is a 6 lb. iron, rated at 1,100 watts. However, it does not draw 1,100 watts continuously. Only a portion of the time while on the stand and not at all while off the stand. The flow of current is controlled by a thermostat. One of the features is the handle construction which is designed to prevent the operator's hand from touching metal parts.

The iron has no projections except two small prongs at the rear which rest in slots and establish contact through the stand, causing it to heat rapidly when first put in use. Thereafter it is kept sufficiently hot by simply placing it on the stand while preparing the article to be ironed. The intended retail price is \$8.90.—*Radio Retailing*, January, 1932.



New Price on Kraft Fireplace-Radio

SINCE describing the radio concealed in a fireplace in the December issue, J. Kraft, 225 Fifth Ave., New York City, has revised the price of this equipment. The intended retail price is now \$165.—*Radio Retailing*, January, 1932.



Sylvania Tube Analyzer

SYLVANIA'S new tube analyzer is the last word in testing devices. Accuracy is combined with beauty of design and economy of space, in both the combination display analyzer and the counter analyzer. The combination display analyzer is a combination of testing unit and show-case, both of genuine walnut stock. Chromium plated fittings, an electrically illuminated and mirrored display, set off to best advantage the three-sided crystal glass panelled front. The lower rear compartment is fitted with special shelves where a complete tube stock may be maintained under lock and key.

The analyzer unit itself is small. Overall dimensions are: width, 25 in.; depth, 14 1/2 in. height, 16 1/2 in. Meter readings on this instrument are easy to read. The dial is marked off into red, pink and green divisions. Red, defective; Pink, doubtful; Green, satisfactory. All the types of tubes may be tested including rectifiers. Provision has been made for future new types.

The counter analyzer is designed for use in stores where the floor space does not permit the use of the combination display analyzer. Made by Hygrade-Sylvania Corp., Emporium, Pa.—*Radio Retailing*, January, 1932.



Apex Washer and Vacuum Cleaner

MODEL 25 wringer type washer made by the Apex-Rotarex Corp., Cleveland, Ohio, is equipped with motor driven water pump. It has silent pump gear, Lovell wringer, semi-soft oversize wringer rolls and vitreous enameled Armco steel tub. Wringer and tub cover are nickel-plated. \$89.50.

Model Apex A-33 vacuum cleaner to be used on either a.c. or d.c. is \$19.85.—*Radio Retailing*, January, 1932.

Horns for P.A. Systems

THE first in a full series of all-metal trumpet horns has been offered to the sound projection trade by the Fox Engineering Co., Toledo, Ohio. It is said that this horn is entirely free from rasping and vibration noises.—*Radio Retailing*, January, 1932.

Multicoupler Antenna System

HART & Hegeman Division of the Arrow-Hart & Hegeman Electric Co., Hartford, Conn., presents the new Amy, Aceves & King, Inc., system of radio wave distribution. This permanently wired-in antenna system provides for as many as 25 sets served by a single aerial.

A patented system of wires run in conduit from the common aerial to an "H&H" radio outlet in each suite.

Through special arrangement with Amy, Aceves & King, any individual problems will be worked out, and layouts made for any special requirements, without charge.—*Radio Retailing*, January, 1932.

Auto-Radio Suppressor Kits

NOISE generated by the electrical system of the automobile and interfering with the enjoyment of the automobile radio set, may be eliminated by the installation of a kit of I.R.C. motor radio suppressors. The kits are available for four-, six- and eight-cylinder automobiles, with the resistors packed in a neat display carton. Individual suppressors are available if desired.

In meeting the requirements of motor radio suppressors, the

engineers of the International Resistance Company, Philadelphia, Pa., have developed units to fit most makes of cars.—*Radio Retailing*, January, 1932.

Speed "Foto-Lectric" Tubes

CABLE RADIO TUBE CORP., 84 N. 9th St., Brooklyn, N. Y., has added to its line the following: foto-lectric tubes, listing at \$20; wall-electrode type television tubes, \$3.50, and crater type television tubes, \$7.50.—*Radio Retailing*, January, 1932.

L & H Electric Range

MODEL 880 electric buffet range is the latest type to be placed on the market by A. J. Lindemann & Hoverson Co., Milwaukee, Wis.

Four finishes, to meet every preference and harmonize with any color scheme, are available. It is equipped with three service drawers, appliance outlets, chromium plated towel rack, dish holders, and salt, pepper, sugar and flour condiment set. Time control may be had as extra equipment.—*Radio Retailing*, January, 1932.



"Visameter" Tube Tester

AFTER several months of intensive research and experimentation, the National Union Radio Corp., 400 Madison Ave., New York, has had built to its specifications a tube testing device known as the "Visameter." A feature of this device is the simplicity of operation which enables the customer to test his own tubes, while the dealer stands by. Readings are simple and easily understandable. By means of a vivid color chart background, the dials immediately designate radio tube condition as "replace," "fair" or "good." Another unusual feature is the "noise test," which is performed through a loud-speaker built into the cabinet.

It tests tubes by the mutual conductance method, has a separate socket for every type of tube, a number of pre-heating sockets and several sockets for possible future tube developments.—*Radio Retailing*, January, 1932.

Microphones

DESIGNED to meet the most exacting requirements for high quality sound recording the condenser microphone of Shure Bros. Co., 337 W. Madison St., Chicago, has a relatively uniform response to all frequencies from 40 to 10,000 cycles, it is said.—*Radio Retailing*, January, 1932.

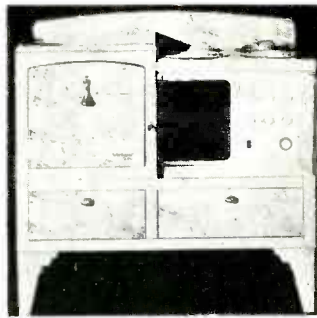

Standard Electric Stove

STANDARD Electric Stove Co., Toledo, Ohio, is now distributing its Model 1236. The switch panel is concealed behind a swinging door as shown in the photo. This model also has plate and food warmer, both new features in construction. It is finished in either white or ivory, with marbled panels or in solid white or colors, as desired. It is equipped with four burners.—*Radio Retailing*, January, 1932.

Horn Chassis

MODEL 15-M 6-tube chassis has three t.r.f. stages and four tuned circuits. The speaker is an 8-in. electrodynamic. Dimensions, 11½ in. wide by 8 in. deep by 9 in. high. This chassis is also built to include long wave apparatus, giving coverage from 220 to 590, and from 900 to 2,000 meters. This provides two receivers in one. The chassis can be used in a mantel-type cabinet.

Model 59 is a straight 8-tube superheterodyne, using 3 multimus, 2 '27s, two pentodes in push-pull, and an '80.

Model 100 is a 12-tube short wave-medium wave chassis. The medium wave unit incorporates 8 tuned circuits, tuned pre-selector stage and signal frequency amplifier preceding the translator tube. The short-wave unit consists of first detector and oscillator, using a 24 and a 27 type tube. It has three pairs of coils, ranging from 17 to 110 meters.

Model 109 has the same specifications, but without the short wave chassis.—*Radio Retailing*, January, 1932.

Jewell Service Instruments

A SINGLE compact unit providing all necessary servicing functions has been developed by the Jewell Electrical Instrument Co., 1650 Walnut St., Chicago. It is known as Pattern 531, professional combination, and includes Jewell Pattern 444 Set Analyzer, compact oscillator and a power unit that supplies power for testing all tubes independently of a receiving set.

Jewell also has a new radio service oscillator, Pattern 563, employing one 30 type tube, operated from self-contained batteries in a self-modulated circuit. The output is continuously variable over three frequency ranges: 550 to 1,500, 125 to 185, and 175 to 450 k.c. A trimmer adjustment allows any much-used intermediate frequency to be "spotted" at a convenient point on the scale.—*Radio Retailing*, January, 1932.

Radio Cabinets

ILLUSTRATED Model NE 325 cabinet is one of many which can be obtained from the Northeast Sales Corp., 5 Union Square, New York City. It is of the popular six-legged type, and stands 49¼ in. high by 27 in. wide. The price in carload lots is \$19.75 f.o.b. the middle west. The price for single cabinet is \$22.75.

This company also has several other models available, ranging in price from \$6 up.—*Radio Retailing*, January, 1932.



Sparton Cabinets

SPARKS-WITHINGTON CO., Jackson, Mich., is offering its dealers a limited number of custom-built cabinets, of which the Tudor model illustrated is typical. The likenesses of Beethoven and Wagner appear in relief on the solid walnut doors of this model. Many of the cabinets in the Sparton custom line are authentic reproductions of old-world masterpieces.

Gothic simplicity is represented by Model 564—hand carved from genuine French walnut. The distinguished individuality of Chippendale finds expression in Model 570. Model 578 sounds a modern French note. With its cabriole legs and exquisite ornamentation, this model is finding wide-spread favor among interior decorators in search of an authentically styled cabinet for homes in the modern French mode.

Chassis furnished with these cabinets are the Sparton series 700 and 800.—*Radio Retailing*, January, 1932.



Bud "Police Thriller"

AN interesting new item being made by the Bud Radio, Inc., 1923 E. 55th St., Cleveland, Ohio, is the "Police Thriller," a device which can be attached to any radio set, to bring in police calls through the speaker with ample volume. This device comes in two types, one retailing at \$2.50 and the other at \$3.50.—*Radio Retailing*, January, 1932.

product," reasons this dealer. "Therefore, I will point out how much better are the new sets than the old—featuring such things as automatic volume control, super-heterodyne selectivity, sensitivity and more natural tone.

This is a unique slant on advertising which seems worthy of thought. Maybe the industry as a whole has spent too much money of late popularizing broadcasts (which are already generally appreciated) and too little driving home the ability of new sets to get familiar features better!

DISPOSING OF TRADE-INS

THE proper disposition of trade-ins is an important part of replacement business. Zanglein affirms that the outstanding blunder of the age is the widespread effort of dealers to avoid taking trade-ins entirely. (Several Rochester dealers actually refer to him people who are in the market for new equipment, but insist upon receiving trade-in allowances.)

"Dealers must face the problem squarely, just as have other industries, if they hope to corral much replacement business and the sooner they do it the better.

"Most of the sets offered in trade are a.c. types which can be put in good condition by making a few minor repairs. These can be resold at a profit if good judgment is exercised in making allowances and salesmen master the technique of merchandising them to people who require inexpensive equipment. There is no trick formula by which trade-in business can be transacted at a profit. Either the department has good appraisers and good salesmen or it hasn't."

Making money on trade-ins is apparently a matter of "horse trading." No hard and fast rules are possible, or desirable. It is interesting to note, however, that even in these days of cheap midgets Hickson Electric contends that it rarely allows more on a trade-in than it is estimated to be worth on the re-sale market and that the trade-in department, as a separate division of the company, operated at a profit in 1931.

Battery sets are taken in only when a market for them is known, and then at the lowest possible figure, or where the margin on the new set is sufficient to justify the junking of the trade-in. Fortunately, there are few such sets still in use. This applies as well to electrified receivers which are so ancient as to be practically useless and to models which require extensive repairs.

There are two methods of liquidating the more presentable a.c. models—and some relatively new midgets and consoles that have been traded in. The probable re-sale value of such sets, and not the gross margin on the new receiver, is used as an allowance yardstick. They are either put in good condition and re-sold, or broken down for their usable parts.

Most of them are marketed to people who cannot afford better sets and this is not considered difficult by the Hickson organization. Company salesmen, according to Zanglein, repeatedly convince such prospects that it is better to buy a full-size re-built set than an undersized midget. The trade-in, it is pointed out, usually has better tone, is invariably superior in appearance and carries with it the same service and replacement guarantee offered on new equipment. "Newness" alone is not proof of a receiver's quality. And the attractiveness of the re-built job is further enhanced by offering it at extremely low terms, made possible by the low investment in the merchandise. Trade-ins are frequently installed without a down-payment.

Under such a plan, we are told, it is folly to sell trade-ins at the allowed price. Something must be added for handling, for installation and for possible service costs.

Every third week accumulated used sets are put into a special display window. This not only moves most of them but also serves to remind people with similar models that their own equipment is considered antiquated. Some sets are sold to Rochester schools to be used in instructing students. And an electric clock cabinet (see photo) which costs the company \$16.25 and sells for \$69.50 together with a re-built chassis is at this moment proving particularly useful in keeping trade-ins profitable.

Many a.c. receivers produced by concerns now defunct are torn down for their parts. These are re-sold to people requiring service on sets of the same type, a prolific source of profit to the concern and also a priceless service to customers who could not obtain parts elsewhere. The concern's stock of repair parts has brought it many service customers, many of whom develop into prospects for replacement sets.

Sales: 53 per cent to people with sets. This was Hickson Electric's experience in 1931. And the percentage will be still higher in 1932. For Zanglein will continue to concentrate on users of old equipment for most of his new business.

Service Men Must Organize

Editor, *Radio Retailing*:

IN MY ten years' experience in radio servicing, I have read many articles about the correct charge for service. One man thinks 50c. for a call and 75c. by the hour for bench work is about right. Another berated those who charged less than \$1 as being unprofessional. It is not my intention to criticize anyone, but rather to express my views.

We have all kinds to contend with. The amateur, the man who *thinks* he know his business and the one who *really* does. All these classes will continue to exist until service men organize and set up standards and then ac-

cept or reject newcomers according to their qualifications.

As radio receivers become more complicated and with television around the next corner—or the next—it is high time for radio service men to organize, set their standards and stick by them. J. P. Kennedy of *South Bend*, is on the right track. I read his article in *Radio Retailing*. He is an asset to the profession.

Come on men, let's thresh this thing out and force every man to become a service man in the fullest sense of the word or move on and make room for those who will.

Ironwood, Mich.

L. W. VAN SLYCK.



VOICES

from the

MARKET PLACE

Laughter, While Shaving

Editor, *Radio Retailing*:

IF THE average radio dealer had any sense of humor he would laugh himself to death when he looked in the mirror to shave.

Any man who has allowed a potentially good business to degenerate into a system of barter and price-cutting ought to laugh at himself. This radio business should be one of the best there is. It ought to pay a man 10 per cent on his time and investment. Does it? Ha, ha!

I am fully aware that most dealers blame all their troubles on the manufacturers. Heaven knows, I hold no brief for some of the actions that have come from the factories. What I think of some of these performances would have to be written on asbestos. The manufacturers cannot claim immunity from blame for the present mess. But, after all, are we dealers morons? Have we got to have some one take us by the hand to lead us across every street we come to?

Regardless of what the manufacturers do, the cure is in our own hands. If, to stay in radio, we have to buy business, at a rate of barter that leaves us with a deficit on every sale we make, do we show much evidence of brains in remaining in such a business? On the other hand, it needs only honest cooperation among dealers to bring the barter side of our business under control.

One thing is certain, if we dealers do not get together to put our business on a sound basis, the factories are going to take a hand. The manufacturers will act in various ways, but the end is going to be that dealers will be forced to change their present bartering selling methods. The factories are going to be reluctant to take any radical step. They will delay as long as possible. We dealers today could do more than the manufacturers ever will, if we would cooperate to revise our bartering.

Here, then, is a message for every radio dealer. Its lessons apply directly and pointedly to the present business practices which extend from Cortlandt Street to Main Street—from coast to coast!

Livingston, Montana.

DWIGHT REED.

Wanted—One Pretty Girl

Editor, "*Voices*" Department:

IHAVE always maintained that the possibility of sales from window displays is in direct proportion to the number of worthwhile people that such a window will stop—and hold. A good window trim will attract a certain amount of attention; action will arrest some of that attention—but a pretty girl will hold it. Add sound and action and a big crowd at all times will be assured.

The other day I proved my theory that such a set-up and such a crowd means sales:

It was a tube trim. Action was achieved by having a pretty girl change the tubes in an operating set, in the window, at frequent intervals. Of course an amplifier carried the program to those outside. Interest was further held by using bad tubes for a space, the girl flashing a card to this effect (she also had a mike and did her stuff audibly). Thus the difference between worn-out tubes and good ones was driven right home.

Tube sales jumped fully 15 per cent at once, and held to this new level long after the window was pulled.

MARTIN BECHTOLD,

Denver, Col.

Bechtold Music Co.

Speaker on Natural Bridge

Editor, *Radio Retailing*:

YOU probably have heard something about it already, but I write this on the chance that you haven't.

We took some relatives down to Natural Bridge, Va., over the last week end. We found that they had installed a loud speaker high up in the arch of the bridge and by playing organ music, on a record I suppose, produce a very remarkable effect. Undoubtedly the details of the installation would be readily given by the Natural Bridge Co., Natural Bridge, Va., which owns the hotel and the bridge property.

It seems to me there are many opportunities for amplifier installations in places of public interest.

Alexandria, Va.

PAUL WISHON.

For Higher Prices

Gentlemen:

IN VIEW of the present propaganda for higher prices, it may be of interest to note that our association went on record in May, 1930, to this same effect.

This resolution was mailed to every set manufacturer. Many replied that they would do everything in their power to follow the suggestions in it.

In the light of subsequent history, it is now apparent that only some general action by the entire group of manufacturers will correct this situation—possibly by a further tightening of the licensing arrangement.

WILLIAM P. MACKLE, *Managing Sec.*

St. Louis Radio Trades Assn.

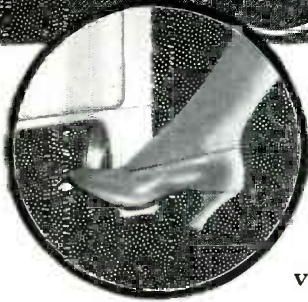

Only Leonard has the LEN-A-DOR—a touch of the toe and the door swings open.

The Refrigerator with the Extra Features

THE NEW LEONARD ELECTRIC

They are calling the new Leonard Electric the "refrigerator with the extra features". That is what makes it so easy to sell—new conveniences, new talking points, new beauty—without penalty of price.

Features like the LEN-A-DOR, for example, appeal instantly to buyers. So it is with the Chill-om-eter, the all-porcelain cooling unit, the Sanitrays, egg basket, vegetable crisper, improved hardware, broom-high legs, one-piece porcelain interior, and many others. Some of these are exclusive with Leonard; others are found only in larger,

more expensive electric refrigerators. And behind these "extras"—which command no extra price in Leonard—is quality of design and construction, resulting from more than half a century of experience in household refrigeration.

The new Leonard line (8 new models—2 all-porcelain) and the Leonard franchise deserve investigation by radio dealers who are seeking a product that will level the valleys of seasonal selling and insure year-round profit. If you are interested in this unusual opportunity, wire or write without delay, as open territories are being rapidly closed.

LEONARD REFRIGERATOR COMPANY

14259 Plymouth Road, Detroit, Michigan

LEONARD

ELECTRIC REFRI



(424)

when manufacturers place a double stamp of approval on Centralab Products

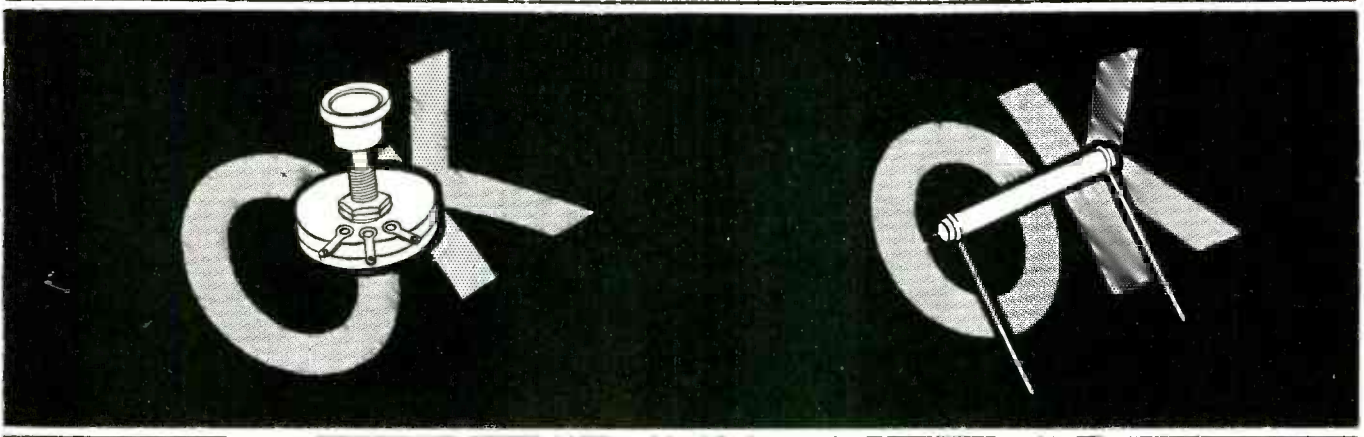

While it is true that the customer seldom knows or even cares about the "innards" of a radio receiver, the alert dealer should know what "makes the wheels go round."

Send for
FREE
Booklet
describing
CENTRALAB
Fixed
Resistors

The dealer who is a technician as well as a merchant can appreciate why an increasing number of manufacturers specify CENTRALAB Volume Controls and CENTRALAB Fixed Resistors.

Write for
new
Centralab
Volume Control
Guide.
Price
25c.

Both products have the unqualified stamp of approval—the definite "O.K." of hundreds of engineers and laboratory workers; as well as thousands of servicemen who have found CENTRALAB Replacement Units remarkably effective and satisfactory.

CENTRAL RADIO LABORATORIES, MILWAUKEE, WIS.

Centralab
CENTRAL RADIO  LABORATORIES

Here's how to bring more people into your store—

1—Look at **THE AMERICAN WEEKLY** every Sunday

2—Note the products advertised on its pages

3—Display those products in your windows and on your counters

—because this mighty magazine, with its 5,500,000 circulation, influences the buying habits of nearly twice as many families as any other magazine in the world.

THE AMERICAN
Greatest Circulation in the World
AWEEKLY

Main Office: 959 Eighth Avenue, New York City

*Branch Offices: PALMOLIVE BLDG., CHICAGO . . . 5 WINTHROP SQUARE, BOSTON . . . 753 BONNIE BRAE, LOS ANGELES . . . 222 MONADNOCK BLDG., SAN FRANCISCO
11-250 GENERAL MOTORS BLDG., DETROIT . . . 1138 HANNA BLDG., CLEVELAND . . . 101 MARIETTA ST., ATLANTA . . . INTERNATIONAL BLDG., ST. LOUIS*

CASH IN on the new LONG PLAYING RECORD



RCA Victor Model RE-18

Here's the instrument that will lead the way for widespread distribution of the long-playing record. Priced in the range of high grade radios, it's a 9-tube Super-Heterodyne radio-phonograph Combination. Synchronous motor, two-speed turntable, packed with special Program Transcription to introduce this type of record. Also plays standard records. Complete with tubes, only

\$147⁵⁰



STEADY PROFITS are yours from this old favorite! The Victor Record, ever a leader in popularity and in profits.

OPEN UP NEW FIELDS with the most sensational advance since the Orthophonic—the Victor Program Transcription.

This New Radio-Phonograph, with two-speed turntable, sells in the price range of radio alone—and opens up the new rich profit field in Victor Program Transcriptions.

THEY'RE sweeping the country together! The new, long-playing Victor Program Transcriptions—and this sensationally low priced radio-phonograph with the two-speed mechanism necessary to play them or the standard Victor Records.

For this instrument is value unapproached anywhere. Two instruments for the price of one. It's a 9-tube Super-Heterodyne with all the features of the RCA Victor 10-Point Synchronized Tone System—plus the first dual-speed phonograph at a popular price.

Show it—and it sells. And every sale of an RE-18 means a steady stream of Program Transcription repeat sales.

Cash in on the sensation the long-playing record has created. Display this instrument—this is only one of RCA Victor's new 1932 opportunities of up-and-coming retailers. The RCA Victor Company, "RADIO HEADQUARTERS," Camden, N. J. (A Radio Corporation of America subsidiary.)



RCA Victor

Radios Phonograph Combinations Victor Records



**It
won't
take you an
hour to
find out**

THE surest and quickest way to find out which electric refrigeration franchise offers you the biggest opportunity is to follow this suggestion—call ten or a hundred women to whom you have sold radios and ask them this simple question—“Which would you rather have, an electric refrigerator in which the freezing speeds were controlled manually by setting a dial or one which was *fully automatic*—with no dials to set—nothing to remember or forget—no danger of freezing the contents of the food compartment?” Invariably, you will find they prefer *fully automatic operation*—complete refrigeration, with 4 different temperatures at the same time, controlled

automatically without attention or supervision.

This one feature alone—*fully automatic operation*—makes Kelvinator the most salable electric refrigerator built because *only Kelvinator is fully automatic!*

We welcome the opportunity of discussing this, and other desirable features of the Kelvinator franchise, with progressive radio dealers who want a profitable and permanent electric refrigeration hook-up. Send the coupon below.

KELVINATOR CORPORATION
 14263 Plymouth Road Detroit, Michigan
 Kelvinator of Canada, Ltd., London, Ontario
 Kelvinator Limited, London, England



Kelvinator Corporation, 14263 Plymouth Rd., Detroit, Mich.
 Gentlemen:—
 I would like to have more information about the Kelvinator Full-Profit Franchise.

Name _____
 Street Address _____
 City _____ State _____

.430)

Kelvinator





FADA

SYLVANIA

MAGNAVOX

DE FOREST

J. C. PENNEY

ATWATER KENT

SEARS-ROEBUCK

COLONIAL RADIO

SAMSON ELECTRIC

NATIONAL CARBON

WEBSTER PRODUCTS

EDISON-GENERAL ELECTRIC

WESTINGHOUSE DISTRIBUTORS

JEWELL ELECTRICAL INSTRUMENT

★ ★ ★ **AND WHEN IT COMES
TO WOODWORK, THEY COME TO ADLER-ROYAL**

Increasingly during recent years we have had the pleasure of collaborating with some of the world's largest cabinet users.

Many of them, coming to us with little more than general ideas, have said in effect: "Here—you fellows know cabinet engineering and acoustics; design something for us that will do so-and-so".

And we've done it—for manufacturers of radio, television, short-wave receivers, radio-phonograph combinations, tube-merchandisers, sound-amplifying devices, etc.

This growing preference for Adler-Royal is obviously due to its long

experience in the production of fine musical instruments, to its ingrained knowledge of engineered cabinet-work and to its unquestioned stability through every changing tide of business.

There is one confession we must make, however: We've never sold orange crates. There is too much competition from the grocery trade.

If you need sound engineering advice, salable designs and irrefragable cabinetwork, we can help you as we have helped those whose names appear above. *Address: Adler Manufacturing Co., Incorporated, Louisville, Kentucky.*

ADLER-ROYAL
cabinets

1928

1929

1930

1931

Speaking of "sales curves"

... and everybody is ...

look at

MAYFLOWER!

Sold thru retail
merchants only
Period-styled
cabinets

Pre-sold by national
advertising

A complete
refrigeration line

Refrigeration
since 1920

HERE is a selling record that challenges the interest of every retail merchant who is considering the tremendous possibilities in electric refrigeration today. Twelve years of sound profitable Mayflower progress, with an amazing increase in sales during the past four years, is proof positive that the Mayflower product and retail merchandising plans are RIGHT. More than 80 per cent. of the market for electric refrigeration yet untouched. *Someone* in your territory will make money representing Mayflower electric refrigeration. That someone can be you. Get the facts. Trupar Manufacturing Company, Dayton, Ohio.

MAYFLOWER
ELECTRIC REFRIGERATION

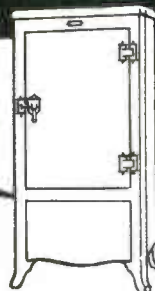

Send us your name and address —and we will send you our book outlining the complete Mayflower retail merchandising plan.

For 32, 115
or 230 Volts
D.C.



**THE ANSWER
to your D.C.
PROBLEM!**

The sensationally low
price of the

**JANETTE
Rotary Converter**

makes it easy to sell A.C. sets
to the thousands of D.C. users
on farms and in cities. You
profit on both receivers and
converters.

Write for dealer discounts
and bulletins.

JANETTE MFG. CO.
555 West Monroe St.,
Chicago, Ill.

Singer Bldg., 149 Broadway, New
York, N. Y.; Real Estate Trust Bldg.,
314 Ninth Ave., N. Seattle, Wash.;
Philadelphia, Pa.; Harrison Sales Co., 324 N. San Pedro Ave., Los Angeles, Calif.

AUDIOLA

"Known for Its Tone"

**SUPERHETERODYNES
AND MIDGETS**

High Grade Set Builders
Since 1921

AUDIOLA RADIO CO.
430 So. Green St. CHICAGO

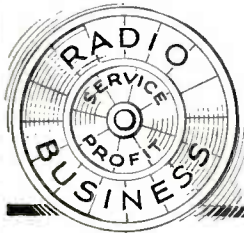

**The WHEEL
WITHIN the
WHEEL...**

INSIDE your radio business is
ANOTHER business — A
SERVICE BUSINESS—the
"Wheel Within the Wheel."

And that SERVICE wheel is
closer to the hub, that supports
all, than many radio men realize.

Our observation shows that radio
men who conduct their Service
Departments as a business which
should show a PROFIT, never
fail to make a profit out of it.

A SURE way to make a PROFIT
from your Service Department is to
use ELECTRAD high-quality replace-
ment parts. They save both time and
money, and give greater satisfaction.



**ELECTRAD
TRUVOLT
RESISTOR**

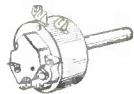

**ELECTRAD
VOLUME
CONTROL**

Mail the coupon for money-
making service helps.

175 Varick St., New York, N.Y.
ELECTRAD
INC.

ELECTRAD, INC., 175 Varick St., New York
Please send me complete replacement
folders and special replacement
Name _____
Address _____
WR-1

on the menu
for february
and march

A BRAND NEW, complete
listing of all household elec-
tric refrigerator manufacturers,
including not only the older, estab-
lished companies but the more re-
cent additions to the ranks will be
published as an editorial service
to radio dealers and distributors in
the February issue of *Radio Re-
tailing*. Names and addresses will
be given as well as data on sizes
and prices—specifications that the
radio trade needs at this time.

Statistics on radio set sales and
saturation, radio tube sales, ac-
cessory sales and enough other
worthwhile and usable figures
to gladden the heart of the radio
business man will make their
appearance in *Radio Retailing's*
March issue—the Annual Sta-
tistical Number.

Dealers and distributors will be
interested in the service afforded
by these two important forthcom-
ing numbers. Manufacturers will
be interested in the advertising op-
portunities offered by the two
issues.

Radio Retailing

a McGraw-Hill publication

Member ABC and ABP

Which one for profits?

The radio dealer who goes into the electric refrigerator business this year will carefully examine the possibilities of the four or five leading lines. He will want to know which manufacturer can give his type of dealer the practical cooperation and counsel, based on experience, that will guide his selling. He will want to know which line is complete enough to put him all the way into the business. He will want to know which refrigerator offers the most in convenience features . . . He will find that Copeland's dealers, last year, profitably sold more refrigerators than in any year in Copeland's history—that Copeland's complete line — Copeland's leadership in convenience features — plus Copeland's specialized dealer plan, played a big part in Copeland dealers' success. He will find the profit he is looking for, in Copeland.

Copeland

DEPENDABLE ELECTRIC REFRIGERATION

COPELAND PRODUCTS, Inc., Mt. Clemens, Mich. B

Please send me details of your specialized dealer plan.

Name _____

Firm Name _____

Address _____

JANUARY TRADE AND PUBLIC SHOW

COLISEUM--CONGRESS HOTEL

JANUARY 18-24 INCL.

*'Endorsed by
Radio Wholesalers and
National Federation of
Radio Associations'*

THE Chicago Radio-Electrical Show at the Coliseum January 18th to 24th will Be Held For the First Time As a Combined Trade And Public Show.

Daily meetings for dealers and jobbers.

All new models for the 1932 advance season will be displayed by the industry's leading manufacturers.

Radios
Refrigerators
Electrical
Appliances

Trade demonstrations and manufacturers' individual sales meetings at the Congress Hotel. Public Show at the Coliseum.

Money making sales plans will be introduced.

Reduced railroad fares. Fare and one half plan. Details for obtaining special fare certificates will be sent with trade invitations to be mailed about January 1st.

Radio Wholesalers and National Federation of Radio Associations Conventions, Congress Hotel, Jan. 18-19-20.

Jobbers — Dealers — Servicemen!
LYNCH RESISTOR Replacement Manual FREE
 with purchase of 10 Lynch Metallized Resistors, or it may be bought for \$1.00
 All the RESISTOR INFORMATION you will ever need. Saves TIME and experimenting. Useful, authoritative, invaluable. More than 200 circuits—nearly every popular make of radio receiver. Gives value, code and position of each resistor in the circuit.

LYNCH
RESISTORS

Write today for new reduced prices, or enclose \$1 for Manual.

JOBBERS: Have you received our FREE 50-drawer steel Resistor Cabinet? If not, write to-day for proposition.



Metallized
1, 2 and 3 Watts

Precision Wire Wound
Pigtail and Cartridge Types

Lynch Mfg. Co., Inc., 1775 R, B'way, N. Y.

FULCO RADIO COVERS



"FULCO" Radio Covers insure deliveries in perfect condition—without scratches or broken parts. Well padded, strongly sewed, and made to give maximum service at minimum cost. Also Dust Covers. Write for prices.



Fulton Bag & Cotton Mills
Manufacturers Since 1870
 Atlanta St. Louis Dallas
 Minneapolis Brooklyn New Orleans Kansas City, Kan.



RADIO WIRE PRODUCTS

ANTENNA WIRE	LEAD-IN WIRES
ANTENNA KITS	HOOK-UP WIRES
ANTENNA ACCESSORIES	ANNUNCIATOR WIRES
LIGHTNING ARRESTERS	CABLES

WRITE FOR CATALOG AND PRICES
 If Your Jobber Cannot Supply You—Order Direct

CORNISH WIRE CO. 30 CHURCH ST., NEW YORK, N. Y.
Makers of the Famous

BRAIDITE HOOK-UP WIRE

Only Reliable Products
 can be continuously
 advertised

GET 1932 RADIO FACTS

... Read Radio Retailing Regularly

RADIO RETAILING is read by 25,000 progressive radio merchants, radio and electrical wholesalers, department store managers and buyers, central station merchandise managers, radio service men, and other dealers interested in the sale of all home entertainment products.

RADIO RETAILING brings to those men a "dollar value" return unequalled by any other radio publication. It is not a "fan" magazine. It is the clearing house of all the practical selling ideas developed by salesminded distributors of radio sets, television receivers, portable and auto radios, phonograph combinations, 16 mm "home-talking" movies, shortwave sets, tubes and allied items.

RADIO RETAILING is not sold on any newsstand. It is sold through subscription only and mailed direct to recognized dealers once each month. Don't depend on some one else's copy. Have your own mailed direct to you for less than 9c. a month.

Special Half-price Offer

The regular price of **RADIO RETAILING** is \$2 a year. Here is your opportunity to secure a full year's subscription *at just half-price*. Simply send in \$1 with the coupon below and the next 12 issues will be sent to you. Check, money-order or currency may be sent at our risk. **PAYMENT MUST ACCOMPANY ORDER** at this low rate.

Mail this coupon  with \$1.00 **TODAY**

SAVE \$1 WITH THIS COUPON

The regular price of *Radio Retailing* is \$2 a year. This coupon and a check, money-order or cash for \$1 will bring you the next 12 issues of this practical dealer merchandising service at 1/2 the regular rate.

Mail Your Order — NOW

Payment must accompany order as we cannot bill at reduced rate.

SEND MONEY AT OUR RISK

RADIO RETAILING, 330 W. 42d St., New York, N. Y.

RR 1-32

Here is my \$1. Enter my name for a year's subscription (12 months) to *Radio Retailing* at special half price rates starting with the January number.

Check here if you are already a subscriber and want your subscription extended at special \$1 price.

Name

Address

City..... State.....

Company..... Position.....

Nature of Business.....

Price outside U. S. and Canada \$3 a year. Price in Canada \$2.50 a year, payment with order only.

COUNTER TUBE TESTER

No. 406

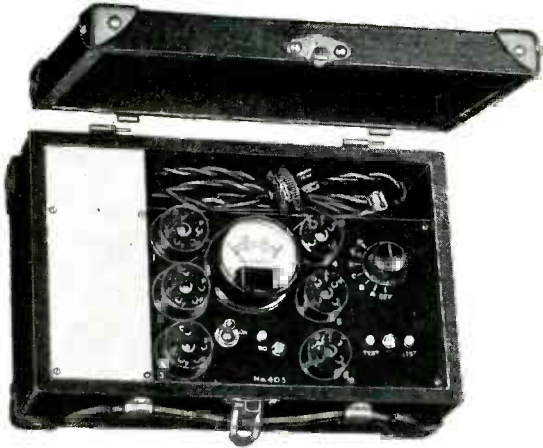

\$15.00 DEALER'S PRICE
(60 Cycle)

SOMETHING NEW

*A Simple A.C. Tester
with only one button to press*

Readrite

ILLUMINATED DIAL—easy to read.
REMOVABLE METER in tip jacks.
RENEWABLE FUSE attached to
bottom of meter.

Tests all tubes, including rectifier (both plates) pentode, power and screen grid. Handy card—lacquer covered—shows reading of all tubes, no adapters, with removable cover, in a strong leatherette covered case. Rubber feet and leather corners.

A tester for new and old tubes you can always rely upon. Fully guaranteed. Get yours today at your jobbers. If not available remittance must accompany order for direct shipment.

Readrite Meter Works

Established 1904

16 College Ave.

Bluffton, Ohio

SHORT-WAVE BUSINESS MAY CARRY YOU THROUGH 1932—ARE YOU READY FOR IT?

SERVICING AND TESTING MAY KEEP YOUR BUSINESS ALIVE.

WHAT ABOUT TELEVISION?

You cannot afford to ignore these chances for income. This year above all, you will have to keep on your toes—every minute. Your service men will have to be experts too.

What are you going to do about it?

Here is our best suggestion. Fill in the coupon at the bottom of this page and get these books into your hands as fast as you can.



MOYER AND WOSTREL'S

RADIO CONSTRUCTION LIBRARY

(3 volumes—1119 pages—615 illustrations)

FREE EXAMINATION

Send for these books and examine them FREE for 10 days at our expense. We pay the postage, even if you send them back. But send for them and see if you do not agree with us that having them in your home or shop is like having another first-rate radio man to advise and help you.

WHAT THE BOOKS CONTAIN

Volume 1. **Practical Radio**. 410 pages. 236 illustrations and diagrams. Presents the fundamental principles of radio so clearly and simply that anyone of average training will be able to understand and apply them. Deals with recent developments in television, including devices for its practical application. The latest types of photo-electric cells and neon glow tubes for television services and the difficulties of "scanning" are fully explained. Contains full information needed to understand newer types of receiving tubes, especially those for operating with alternating current.

Volume 2. **Practical Radio Construction and Repairing**. 386 pages. 179 illustrations and diagrams. Discusses fully all the elemental principles of radio construction and repair. Includes such subjects as: Sources of electricity for radio tubes—Audio frequency amplifiers—Construction of impedance coupled and "Universal" four tube receiving sets—Short wave receiver—The television receiver—and many others.

Volume 3. **Radio Receiving Tubes**. 323 pages. More than 203 illustrations and diagrams. Clearly explains the essential principles underlying the operation of vacuum tubes. Includes complete information on the newest types of radio tubes and improvements which have been made in tubes already in general use. Gives complete descriptions of apparatus required for radio receiving sets and for industrial equipment; also of devices utilizing radio receiving tubes as essential parts, particularly in the field of radio surgery, where applications of the radio needle have met with success.

SMALL PAYMENTS

Examine these books for 10 days FREE. Then, if you keep them, just send us \$1.50 at that time and \$2.00 a month until the small price of \$7.50 has been paid. But do it now and start the New Year Right.

McGraw-Hill FREE EXAMINATION COUPON

McGraw-Hill Book Co., Inc., 330 West 42d Street, New York.

Gentlemen:—Send me the RADIO CONSTRUCTION LIBRARY, all charges prepaid, for 10 days' Free Examination. If satisfactory I will send \$1.50 in ten days and \$2.00 a month until \$7.50 has been paid. If not wanted I will return the books at your expense.

Name

Home Address

City and State

Name of Company

Occupation R.R. 1-32

To insure prompt shipment, write plainly and fill in all lines.

SEARCHLIGHT SECTION

EMPLOYMENT and BUSINESS OPPORTUNITIES—SURPLUS STOCKS—DISCONTINUED MODELS

UNDISPLAYED—RATE PER WORD:
 Positions Wanted, 5 cents a word, minimum \$1.00 an insertion, payable in advance.
 Positions Vacant and all other classifications, 10 cents a word, minimum charge \$2.00.
 Posopsals, 40 cents a line an insertion.

INFORMATION:
 Box Numbers in care of any of our offices count 10 words additional in undisplayed ads.
 Discount of 10% if one payment is made in advance for four consecutive insertions of undisplayed ads (not including proposals).

DISPLAYED—RATE PER INCH
 1 inch.....\$7.50
 2 to 3 inches..... 7.25 an inch
 4 to 7 inches..... 7.00 an inch
 Rates for larger spaces, or yearly rates, on request.
 An advertising inch is measured vertically on one column, 3 columns—30 inches—to a page. Radio Retailing

RADIO DEALERS RADIO SERVICEMEN

NEW Radio Handbook

CONTAINING:
 Technical Information.
 Volume Control Guide.
 Transformer and Condenser Guide.
 Radio Replacement Parts Catalog.

Sent postpaid anywhere for only
25 Cents

Specials from our Catalog

Atwater Kent 37 Block with chokes } \$2.95
 Atwater Kent 37 Transformer, ea. }
 Majestic Super "B" Eliminator Block } \$2.25
 Electrolytic 2 anode Condenser, ea. }

Hard To Get Parts—We have them.
 Send us your repair work for estimate.

Grant Radio Laboratories
 6521-R South Halsted Street, Chicago, Ill.

Electrical RECORDINGS

MADE TO ORDER

24 Hour Service, Finest Quality new metal alloy recordings; For Announcements; Public Address Sound Truck Advertising, Etc. Low cost, long life, light weight, unbreakable records, all sizes
 Write for details. ROYAL RECORDING & FILM STUDIOS, Dept R. 661 N. Michigan Ave., CHICAGO.

The Buyer—
 The Employer—
 The Agent—
 The Seller—
 The Employee—
 The Dealer—

You can reach
 them all through the

SEARCHLIGHT SECTION

Searchlight Advertisements are quick acting. They usually bring prompt returns. There is no better way to reach the men of the RADIO field at small cost.

Address

SEARCHLIGHT SECTION
 330 West 42d St., New York, N. Y.

All inquiries answered promptly

SPECIAL NOTICE:

To the Radio Industry

Advertising in connection with legitimate offers of surplus stocks and discontinued models of radio merchandise is acceptable in this section of "Radio Retailing."

Extreme care will be exercised by the publishers to prevent the use of advertising in the Searchlight Section to encourage price cutting on current models of merchandise or equipment. Nor will advertising which invites violation of the dealer's contract with the manufacturer be acceptable.

All merchandise offered in the Searchlight Section must be accurately and fully described and must be available on order.

REPRESENTATIVES WANTED

Exclusive Radio Service Representatives
 Wanted in West, South and Middle West. This nationally known radio parts institution is about to appoint exclusive representatives to call on radio dealers already doing business with us. State radio service, selling and other experience, also what you are doing now. RW-153, Radio Retailing, 520 No. Michigan Ave., Chicago, Ill.

WANTED

Wanted: to Buy Radios
 \$1,000,000 Pacific Coast furniture store will pay cash for radios for clearance sale. Must be recognized brands that can be sold at drastic reductions. W-158, Radio Retailing, Chamber of Commerce Bldg., Los Angeles, Calif.

BUSINESS OPPORTUNITIES

Incorporate Liberal Delaware Laws
 Preparatory financing inventions, business. Secure organizers perpetual control. Reasonable. Booklet, forms free. Universal Charters, Dover, Del.

YOUNG EXECUTIVE

knowing all principal radio manufacturers is interested to establish himself with manufacturer of contributing parts, moderate investment available if required, interviews invited.

BO-157, Radio Retailing
 330 West 42d Street, New York City

PROFITABLE SERVICING

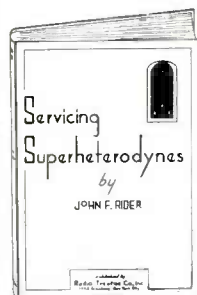

John F. Rider's

Servicing
**Super-
 heterodynes**

is the book you need to cut superhet servicing time in half. This new book will give you all the information you require about superheterodynes in order to rapidly and profitably repair this type of receiver.

Not only does the book give you a complete and thorough explanation of the principle of the superheterodyne, starting with beat notes and ending with variable mu and pentode tube replacement—but it contains actual trouble shooting information—the troubles which cause certain symptoms and the analysis of the troubles.

161 pages, type set, pocket size, bound in stiff canvas cover — Sold With A Money Back Guarantee.

Price \$1.00 postpaid.

RADIO TREATISE CO., Inc.
 1440 Broadway, New York City

For Sure, Quick Money, Sell Portable Sound-on-Film



to Theatres, Schools,
 Churches, Clubs.

Write for manufacturers' prices on Soundheads, Photocells, Optical Systems, Rectifiers, Amplifiers, Horns, Faders, Synchronous Motors, Projectors, Lamphouses, Screens, Microphones, etc.

S.O.S. CORP.
 (Dept. R. R.)

1600 B'way, N.Y.C. Cable "Sosound"

DISTRIBUTOR WANTED

Established Manufacturer of Electric Appliances has exclusive sales franchise to offer financially responsible distributor with an established organization. Product nationally advertised, 1931 sales greater than in all previous years combined. Peak season from January to July. Exclusive patented features and priced lower than competition. Immediate possibilities greatest of any appliance now on the market. Write advising lines handled and territory covered. All replies treated strictly confidential.

RW-159, Radio Retailing
 520 No. Michigan Ave., Chicago, Ill.

DEWALD

ANNOUNCES

New Super-Heterodyne
New A.C. Super T.R.F.
New D.C. Super T.R.F.

RECEIVERS

LICENSED BY R.C.A. AND AFFILIATES

New and Better Performers
at LOWER PRICES

Not to be Compared with Anything
on the Market for

Quality, Sensitivity and Workmanship
Chassis and Cabinet Models

Write for Full Particulars. Some
Good Exclusive Territory Now Open

PIERCE-AIRO, Inc. 510-518 Sixth Ave.
New York City
MANUFACTURERS OF FINE RADIO SETS FOR TEN YEARS

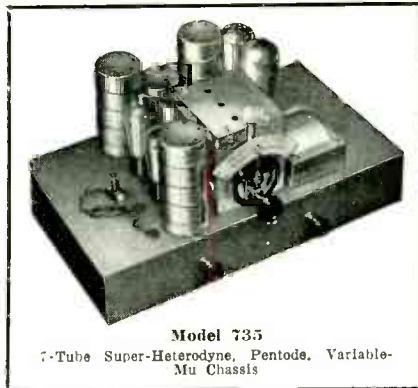

Model 735
7-Tube Super-Heterodyne, Pentode, Variable-Mu Chassis



Model 547-A
Super T.R.F. Pentode, Variable-Mu; Beautiful Cabinet with Electro Dynamic Speaker

ALPHABETICAL INDEX TO ADVERTISEMENTS

<p>▼ ▼ ▼</p> <p>Adler Mfg. Co. 56 Amerian Weekly 53 Arcturus Radio Tube Co. 9 Atwater Kent Mfg. Co. 8 Audiola Radio Co. 58</p> <p>Central Radio Lab. 52 Chicago Radio-Electrical Show. 60 Copeland Sales, Inc. 59 Cornish Wire Co. 60 Crosley Radio Corp. 58 Inside Back Cover</p> <p>Electrad, Inc. 58</p> <p>Fulton Bag & Cotton Mills 60</p>	<p>Galvin Mfg. Corp. 7 General Elec. Co. 4 General Industries Co. 10 Grigsby-Grunow Co. Front Cover</p> <p>Hygrade-Sylvania Corp. 13</p> <p>Janette Mfg. Co. 58</p> <p>Kelvinator Corporation 55</p> <p>Leonard Refrigerator Co. 51 Lynch Mfg. Co. 60</p> <p>McGraw-Hill Book Co. 62</p>	<p>Norge Corporation 5</p> <p>Pierce-Airo, Inc. 64</p> <p>RCA Radiotron Co., Inc. Back Cover RCA Victor Co., Inc. 16, 54 Readrite Meter Works 62</p> <p>Servel Sales, Inc. 6 Shakeproof Lock Washer Co. . . . 3 Silver-Marshall, Inc. Inside Front Cover Sparks-Withington Co. 15 Stromberg-Carlson Tel. Mfg. Co. 2</p> <p>Trupar Mfg. Co. 57</p>	<p>Page</p> <p>Westinghouse Elec. & Mfg. Co. . . 11 Weston Elec. Instr. Co. 14</p> <p>Zenith Radio Corp. 12</p> <p>Page</p>
--	--	---	--

SEARCHLIGHT SECTION

Classified Advertising

BOOKS	63
BUSINESS OPPORTUNITY	63
ELECTRICAL RECORDINGS	63
EMPLOYMENT	63
RADIO SERVICE	63
RADIO STOCKS	
Royal Recording Film Studios	63
Grant Radio Laboratories	63
S.O.S. Corp.	63

This index is published as a convenience to the reader. Every care is taken to make it accurate, but *Radio Retailing* assumes no responsibility for errors or omissions.

CROSLEY

Offers the Greatest

VALUES

in Radio . . .

at lowest possible prices



Low Crosley prices attract prospects to your store.

SUPERLATIVE performance at the lowest possible price! This requirement is uppermost in the minds of those who today are contemplating the purchase of radio receivers. And so, in accordance with the Crosley policy of providing what the public will buy, Crosley has set about to meet this demand.

In doing so, Crosley engineers and technicians have left nothing undone to give you, the radio dealer, and in turn, your customers, the greatest and most sensational values that have ever been offered in the radio industry. Consequently, Crosley radio receivers are in demand today. And they are priced so that the radio dealer can operate at a profit—**TODAY.**

Today's "buyers' market" has put its stamp of approval on the amazing Crosley models. It has professed its satisfaction in terms of greater sales. So perfectly does Crosley reflect the needs, requirements and tastes of the radio-buying public that *no dealer can afford not to handle Crosley.*



The customer automatically "trades himself up."

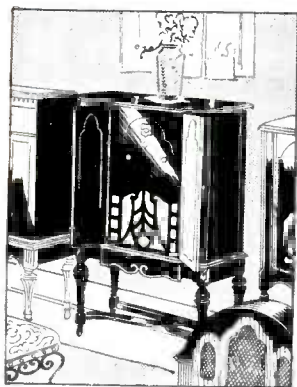

Crosley incorporates the latest radio refinements.



Greater satisfaction for you and your customers.

THE CROSLEY RADIO CORPORATION

Powel Crosley, Jr., President

CINCINNATI

Home of "the Nation's Station"—WLW

YOU'RE THERE WITH A CROSLEY

CROSLEY RADIO

SO MUCH FOR SO LITTLE



The Radiotron Merchandiser in conjunction with a tube tester is much more than an efficient testing panel. The Merchandiser is built primarily to sell. With RCA Radiotrons, as indeed with all packaged renewal items, this means making it easy for the customer to buy. Free testing aids in making it easy to buy by providing an opportunity for doing the customer a service. But this service must be dramatized—must be made to sell itself.



First, attention must be secured. The effect of poor tubes must be emphasized. The entertainment value of broadcasting must be played up. Product and package must be displayed in an attractive manner. All items must be price-marked. And the tube stock and wrapping materials must be within easy reach to make a quick sale. Consider what the Merchandiser was built to do—what it will do for you—and then consider the cost.

RCA RADIOTRON COMPANY, INC., HARRISON, NEW JERSEY
A Radio Corporation of America Subsidiary

RCA Radiotrons
THE HEART OF YOUR RADIO